

## The crimping concept

The crimp connection is an irreversible connection between one or two conductors and a crimp contact. The crimp connection is obtained by pinching or pressing the contact metal - or shaft - firmly with the crimping tool.

A good crimp connection is provided by a suitable combination between the crimping base, the crimping part of the contact metal, i.e. the crimp contact, firmly with and the section of the conductor.

These comments refer to crimped connections carried out with copper flexible conductors in class 5 (flexible) or 6 (extra flexible) according to standards IEC 60228 and IEC 60228-A (Italian standard CEI 20-29).

Solid copper conductors (class 1) or in other materials (aluminium, iron, etc) often require special precautions for contacts and for crimping tools, to be agreed with the manufacturer.

The main technical advantages provided by crimping connections over soldered connections are:

- The process does not use heat and does not require materials.
- Perfect connection is acquired that is intrinsic with cold soldering.
- No degradation of the elastic characteristics of the female contacts (a problem that arises with soldering temperatures).
- No health risks connected with the use of heavy metals or fumes generated from the soldering process.
- Preservation of the conductor's flexibility immediately upon connection.
- No conductors with burned, discoloured or overheated insulating material.
- Excellent reproducibility of the performances of the electrical and mechanical connections.
- facilitated production controls.

Other advantages obtained by crimping connections over screw terminal connections are:

- Less drop of currency in the connector contacts.
- High stability in time even in the presence of vibrations.
- High duration in presence of corrosion (gastight).
- Individual insertion of the contacts in the connector (it is possible to eliminate unnecessary contacts).
- Less time required for connection.
- Possibility of pre-production of the terminated conductors with crimp contacts.
- Easy substitution of individual contacts during maintenance.
- Possibility of selectively isolating the circuits during maintenance via the extraction of the contacts from the connector.

The crimped connections for wire sections up to 10 mm<sup>2</sup> are covered by the EN 60352-2:2006 European standard equivalent to the IEC 60352-2 Issue 2 (2006-02) international standard.

The **EN 60352-2** standard also includes a practical guide, which lists the following main points.

The quality of a crimped connection is mainly affected by the quality of materials used and by the condition of the crimp contact (in particular the crimp shaft) and wire surfaces.

To ensure a good quality crimped connection, an essential parameter is the wire mechanical retention in the contact.

The standard makes a distinction between the closed crimp shaft, inherently stronger, and the open crimp shaft. ILME crimp contacts are closed crimp shaft contacts, with inspection hole which ensures a higher mechanical performance compared to the open shaft crimp contacts, such as better mechanical sturdiness and stability during operation.

They have been machine turned, thus ensuring a better electrical performance (better conductivity).

2002 Amendment 2 of the previous IEC standard issue controversially unified the minimum resistance to tensile stress values established for open shaft contacts (curve B of old Figure 5) and closed shaft contacts (curve A of old Figure 5) by lowering them to the values (shown in curve B), which can be achieved by open shaft crimp contacts. This has controversially relaxed the suitability requirements both for closed crimp shaft, typically large, machine turned and for crimp tools specially made for these contacts. Several industries continue to prefer the higher performance ensured by closed shaft crimp contacts, the only ones to ensure the higher resistance to tensile stress values believed to be essential for the most demanding industrial applications.

Therefore, ILME continues to refer to curve A of Figure 5 illustrated in the EN 60352-2 (1994) standard: ILME closed shaft crimp contacts, used with

flexible copper wires, featuring a section included in the ranges shown and correctly crimped with the recommended tools, ensure breakage resistant connections at least equal to the values shown in the table shown below (for reference, the corresponding R<sub>t</sub>/S unified tensile stress load value is also shown [N/mm<sup>2</sup>]).

Section S		Resistance to traction R <sub>t</sub> (N)	R <sub>t</sub> /S (N/mm <sup>2</sup> )
AWG	mm <sup>2</sup>		
26	0.12	18	150
-	0.14	21	150
24	0.22	33	150
-	0.25	37.5	150
22	0.32	48	150
-	0.37	55.5	150
20	(0.6)	75	150
-	0.75	112.5	150
18	(0.82)	125	150
-	1	150	150
16	(1.3)	195	150
-	1.5	220	147
14	(2.1)	300	143
-	2.5	325	130
12	(3.3)	430	130
-	4	500	125
10	(5.3)	635	120
-	6	650	108
7	10	1000 <i>(1300)</i>	100 <i>(130)</i>
-	16	<i>1650</i>	<i>103</i>
-	25	<i>2300</i>	<i>92</i>
-	35	<i>2800</i>	<i>80</i>
-	50	<i>3300</i>	<i>66</i>
-	70	<i>3900</i>	<i>56</i>

**NOTE** - For 10 mm<sup>2</sup> wire sections, the resistance to tensile stress shown in *italics* are those specified in the NF F 61-030 standard (for 10 mm<sup>2</sup>, the value in brackets)

The basic criteria used for the resistance to tensile stress values required by EN 60352-2 standard is that such resistance is at least equal to 60% of the breakage unified load of the same annealed copper wire.

This applies to wire sections up to about 1.5 mm<sup>2</sup>; above this section, the ratio is slightly lower as retention is also affected by friction, which increases linearly with the housing diameter, whilst the section increases by the square.

IEC/EN 60352-2 standard, which targets the electronics industry, restricts its requirements to crimp connections for wires with a maximum section of 10 mm<sup>2</sup>. For sections higher than 10 mm<sup>2</sup>, up to 70 mm<sup>2</sup>, the standard to refer to is the NF F 61-030 (1989) French standard which relates to electrical connectors to be used on board of railway rolling stock, in particular for large crimp contacts, such as those manufactured by ILME.

**NOTE** - Alternatively, for wire sections between 35 mm<sup>2</sup> and 300 mm<sup>2</sup>, EN 61238-1:2003 standard can be referred to. This standard requires constant R<sub>t</sub>/S values equal to 60 N/mm<sup>2</sup>, lower than those established by the above mentioned French standard.

## Selecting the crimping tool and relevant controls

When you have selected quality crimp contacts and conductors, the next step and most important step is to select the correct work tool. The practical guide of standard EN 60352-2 provides the following recommendations on the subject.

They list some of the ideal requirements for crimping tools, some optional characteristics, but, above all, they provide a preview of the indispensable controls:

- a) The crimping tools and the contacts used must be supplied by the same manufacturer, otherwise the user must assume all responsibility for the quality and reliability of the crimp connections.
- b) The crimping tools must function correctly and provide a correct crimp without damage to the pin or the component to crimp.
- c) In order to obtain a reliable crimp connection, a crimping device with a mechanism that controls the entire crimping cycle must be used. At the end of the crimping cycle the handles and the ratchet must return to the open position.
- d) In all cases the crimping operation must be made in one single phase, with no further interventions.
- e) The removable parts of the tool such as the crimping dies and the locators must be designed in such a way as to make it possible to be inserted within the tool only in the correct manner.
- f) The tools must be supplied with the appropriate means for a correct positioning of the pins to be crimped and of the conductors during crimping.
- g) The tools must be designed in such a way so that only the necessary adjustments may be made.
- h) The action of the tool must be such that both the pin to be crimped and the fixture of the isolation (when present) are respectively crimped or compressed with a single action.
- i) The design of the tool must ensure that the dies for a particular tool may be interchangeable within tools of the same type.  
If they are not interchangeable, the identification of tools for which they are suitable must be marked on the dies.
- j) The tools may be designed so as to produce a marking or coding of the die on the pin to be crimped so that the crimping may be checked for verification of the correct die.
- k) The design of the tool must allow the verification of the dies with gauges to measure wear. The gauge verification method must be that specified by the manufacturer of the tools.

With suitable flexible copper conductors, the crimping tool proposed by ILME gives 8 impression crimp (see figure) in conformity with standard EN 60352-2.

Periodic control of the wear of the crimping matrixes can be carried out with the appropriate "go - no go" gauges (purchased separately). For extra operational details, consult the following pages on tools, and the relevant instruction sheets and/or use and maintenance manuals.

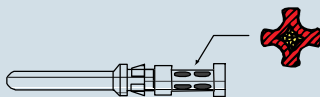

The manual and automatic crimping tools selected by ILME are carefully designed to ensure symmetrical deformation of the crimping area of the contact and wire, by means of their own, internal high pressure forming parts.

The positioner ensures that the wire and crimp contact meet in the appropriate part of the tool. Sprung mechanisms built into the tools ensure that the contacts are not inserted in the tool before the indenters are fully open, and that the tool does not open before the crimping process has been completed.

The **CCPZ MIL** (for 10A and 16A crimp contacts) and **CXPZ D** (for 40A crimp contacts) manual crimping tools are suitable for use when compressed air sources are unavailable, for low or medium-low work loads. The **CCPZ RN** (for 10A, 16A and 40A crimp contacts) manual crimping tool is also suitable for low or medium-low work loads.

The **CCPZP** pneumatic crimping bench tool without automatic positioner (for 10A and 16A crimp contacts) is suitable for use in the workshop (where compressed air is available) for high or medium-high work loads. Using the same manual crimping tool turrets it is possible to change rapidly from crimping on male contacts to crimping on female contacts of the same series (10A and 16A).

The **CCPZPA** pneumatic crimping bench tool with automatic positioner (for 10A and 16A crimp contacts) is suitable for workshop jobs (where compressed air is available) for medium-high or high work loads. It is recommended in particular for crimping high quantities of contacts that are the same type or have the same section, thus saving a significant amount of time thanks to automatic operation and reduced operator fatigue. Where the type or kind of contact must be changed frequently, it is preferred to use the version without automatic positioner.

The **CXPZP D** pneumatic crimping bench tool without automatic positioner (for 40A crimp contacts) is suitable for use in the workshop (where compressed air is available) for high or medium-high work loads. By using the same positioners as those of manual crimper CXPZ D, the size of a contact can be rapidly changed with one of the same type. However, the positioner must be changed in order to change over from male to female contacts.

The semiautomatic stripping-crimping machine, type ZFU-CD, is suitable to be used in workshops (where an electrical or pneumatic power supply is available) and for heavy work loads. It enables to produce large amounts of crimped connections in less time because of the possibility of simultaneously carrying out stripping and crimping operations. The contact and tool replacement operations, which are minimized because of the preset programs that can be stored and customized by the user, require the production to be programmed to reduce downtime. When a sequential processing is required despite the economic advantages offered by the above-described solution, it is preferable to use pneumatic bench pliers without the above-described positioner or one of the manual pliers.

In any case, the quality of the results from the crimping tools, combined with the ILME crimp contacts, is identical and at the highest market levels, exceeding the requirements of the standard EN 60352-2.

Although the crimping appliances and tools suggested here include a set of control automatisms and mechanisms, which prevent the chief misunderstandings and errors, the operator is advised to always take care not to work in inappropriate conditions.

**The crimping operation**

The practical guide in standard EN 60352-2 supplies further general information regarding crimp contacts for multipole connectors.

**1. Insertion of the conductor in the crimp contacts**

The conductor must be correctly positioned in the pin to be crimped. The crimping indentations must be correctly positioned on the foot to be crimped. There must be sufficient space, in conformity with the manufacturer's instructions, between the end of the insulating material of the conductor and the pin to be crimped ("d"). As a general rule, the stripping length is equal to the pin insertion depth + 1 mm (for sections up to 1 mm<sup>2</sup>) and + 2 mm (for sections from 1 to 10 mm<sup>2</sup>). When using closed crimp pins with an inspection hole, the crimp conductor must be visible through the inspection holes.

\* Keeping the conductor strands visible above the contact collar enables you to check correct stripping, i.e. make sure no strands have been cut. This also ensures a certain flexibility for the connection, by not transmitting to the contact any flexure stresses caused by installation. However, in practice, some operators give priority to insulation, by reducing to zero the gap between cable insulation and the contact collar.

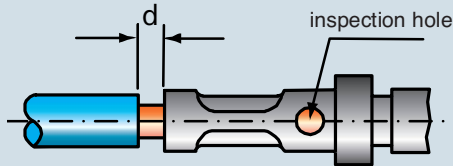

**2. Insertion of crimped contacts in the connector insert**

It is recommended that the crimped contacts be perfectly straight and inserted within the contact slots in a single operation and without excessive force until a clicking sound is heard. The correct retention of the contact should be verified with a light pulling of the wire. Non alignment of the crimped contacts must be avoided because this could cause possible loosening of the retention springs and consequently jeopardise the retention of the contact in the insert. For small section conductors ( $\leq 0.35 \text{ mm}^2$ ) or for specific application, the use of the insertion tool specified by the manufacturer is recommended.

**3. Removal of inserted contacts**

In the case of incorrect insertion or wiring substitution, inserted contacts may only be removed using the removal tools specified by the manufacturer.

**4. Mounting and flexure of multiwired bundles or multipolar cables with crimp contacts**

Bundles of conductors or multipolar cables with crimp contacts for multipole connectors must not cause stress to the inserted contacts with their weight as this would cause the contacts to bend over to the coupling area of the connectors and consequently damage them. The connectors must therefore be provided with cable clamps or the conductor bundles or multipolar cables must be mounted as described in the figures herebelow.

Multipolar cable

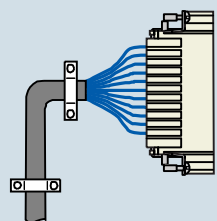

Conductor cables

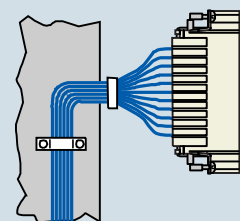

If the conductor bundles or the multipolar cables have to be immediately folded over on the back of the connector insert, it is recommended not to use any mechanical force in the axial direction with respect to the coupled contacts. The figure herebelow shows a correct bending and clamping of the multiwire bundles using the crimp contacts.

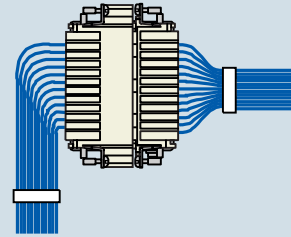

**5. Coupling and uncoupling of multipolar connectors with crimp contacts**

In order to prevent stress on the crimp contacts, the connectors must be coupled and uncoupled in the axial direction with respect to the contacts, without touching the conductor bundles or cables. Standard DIN 43652 (incorporated into specification EN 175301-801) that applies to the ILME inserts of the CD series (this recommendation is also valid for the CDD series) prescribes a maximum deflection from the axis of  $\pm 5^\circ$  on the greater side and  $\pm 2^\circ$  on the smaller side.

correct

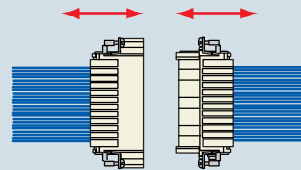

incorrect

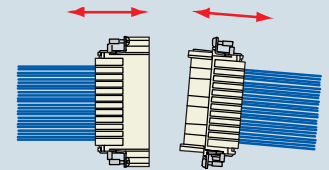

To keep the play within this limit, especially during the uncoupling phase, guide pins CRM and CRF may be used. The use of ILME pliers (code number CPES) is recommended for the uncoupling operations for CD inserts (64 poles) and CDD inserts (108 poles). The pliers work on the fulcrum and lever principle and perform the following main tasks:

- I - Reduce effort and coupling times to the minimum, even when working in the most impractical and inaccessible points;
- II - Perform the uncoupling of multipolar connectors in full conformity of standard DIN 43652 (now EN 175301-801).

The pliers allow the extraction of the inserts to be made perfectly axially with respect to the contacts, evenly distributing the pressure on four points (housing pins).

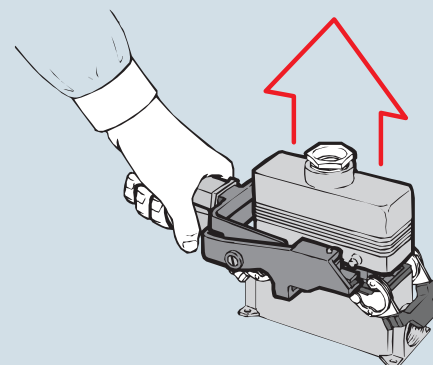

for contacts of insert series:	page:
<b>CD</b> ..... (10A)	45-53
<b>CDD</b> ..... (10A)	59-66
<b>CDC</b> ..... (16A)	73-77
<b>CQ</b> ..... (16A/10A)	69-70
<b>CQE</b> ..... (16A)	80-85
<b>CCE</b> ..... (16A)	94-104
<b>CMCE</b> ..... (16A)	134-146
<b>CX 8/24</b> ..... (16A/10A)	151
<b>CX 6/36</b> * ..... (10A)	152
<b>CX 12/2</b> * ..... (10A)	153
<b>MIXO</b> ..... (16A/10A)	172-184

\* the underlined polarities indicate those contacts that require the tools shown in this page

**manual crimping tool  
turret heads - gauge**



**insertion tool  
removal tools - tip**



description	part No.	part No.
crimping tool for <b>10A</b> and <b>16A</b> contacts DANIELS AF8 model (turret excluded)	<b>CCPZ MIL</b>	
turret heads (see note) - for <b>10A</b> contacts (CDF and CDM series) - for <b>16A</b> contacts (CCF and CCM series)	<b>CCTP 10</b> <b>CCTP 16</b>	
"go / no go" control gauge to verify indenter closure (see note)	<b>CCPNP</b>	
insertion tool for insertion of the contacts into the inserts for crimped contacts up to 0.75 mm <sup>2</sup>		<b>CCINA</b>
removal tools for the extraction of contacts from the inserts - for <b>10A</b> contacts <sup>1)</sup> - for <b>16A</b> contacts <sup>2)</sup>		<b>CCES</b> <b>CQES</b>
replacement tip for CCES removal tool		<b>CCPR</b>

**Notes:**

- for CQ, CD, CDD, CX inserts (10A auxiliary contacts) and MIXO module (10A)
- for CQ, CQE, CCE, CMCE inserts (excluded 16+2) and MIXO module (16A) for CDC, CMCE (16+2), CX inserts (contacts 16A insert CX 8/24) using a flat 3 mm screwdriver.

**Positioning turret**

conforms to international standard MIL-C-22520/1  
- An interchangeable and indispensable accessory of the CCPZ MIL crimping tool, it precisely positions the contact where crimping is performed. Each series of contacts requires its own turret.

**"go / no go" control gauge**

conforms with international standard MIL-C-22520/3  
- A tool used to periodically check that the crimping tool meets standard requirements.

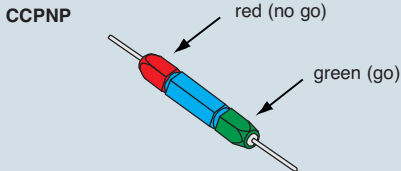

**CCPZ MIL**

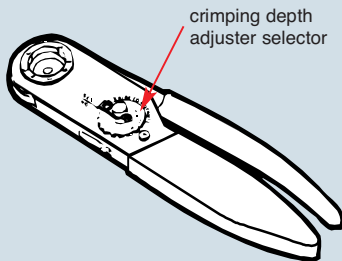

**CCTP**

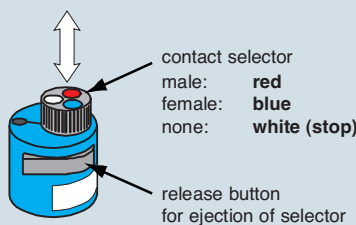

**CCINA**

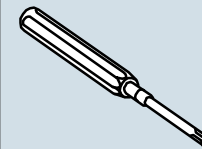

**CCES**

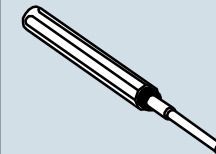

**CCPR RN**

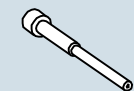

**CQES**

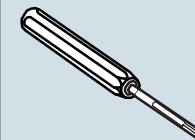

CCMA - CCFA CCMD - CCFD		0.14 mm <sup>2</sup>	0.25 mm <sup>2</sup>	0.34 mm <sup>2</sup>	0.5 mm <sup>2</sup>	0.75 mm <sup>2</sup>	1.0 mm <sup>2</sup>	1.5 mm <sup>2</sup>	2.5 mm <sup>2</sup>	3.0 mm <sup>2</sup>	4.0 mm <sup>2</sup>	conductor section
red male	blue female	26	24	22	20	18	17	16	14	12	12	AWG
0.3	0.3	5	5	6								crimping depth adjuster selector CCTP 16
0.5	0.5		6	7								
0.7	0.7			6	7							
1.0	1.0			6	7	7						
1.5	1.5				6	7	8					
2.5	2.5					6	7	7				
3.0	3.0							6	7	7		
4.0	4.0									7	8	

CDMA - CDFA CDMD - CDFD		0.14 mm <sup>2</sup>	0.25 mm <sup>2</sup>	0.34 mm <sup>2</sup>	0.5 mm <sup>2</sup>	0.75 mm <sup>2</sup>	1.0 mm <sup>2</sup>	1.5 mm <sup>2</sup>	2.5 mm <sup>2</sup>	conductor section
red male	blue female	26	24	22	20	18	17	16	14	AWG
0.3	0.3	5	5	6						crimping depth adjuster selector CCTP 10
0.5	0.5				6					
0.7	0.7					6				
1.0	1.0						6			
1.5	1.5							7		
2.5	2.5								7	

**General specifications**

The CCPZ MIL crimping tool conforms to the international standard MIL-C-22520/1. Crimping is performed with 8 pressure points. The tool is equipped with a geared mechanism to control the complete crimping cycle.

**The tool must be equipped with an interchangeable turret (CCTP) according to the series of contacts to be crimped.**

**Crimping range**

Wire section: dimension from 0.12 mm<sup>2</sup> (26 AWG) to 4 mm<sup>2</sup> (12 AWG).

**Caution!**

**The handle of the tool must be in the open position when the turret is installed, disassembled or opened. If not, the turret and the crimping tool may be damaged.**

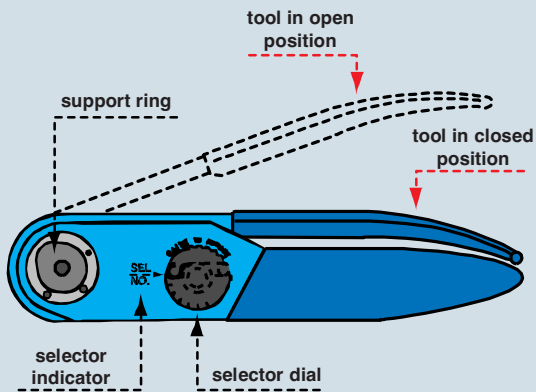

**CCTP turret installation**

1. The crimping tool must be in the open position.
2. Press the clicking lever that releases the turret in the adjustment position.
3. Position the previously selected CCTP turret on the support ring located on the crimping tool (matching the special pin on the base of the turret with the corresponding hole on the support ring), aligning the tapped holes with the socket head screws.
4. With the CCTP turret positioned against the support ring, tighten the socket head screws with the 3.5 mm Allen wrench (supplied with the kit).
5. Refer to the data plate on the CCTP turret. From the colour code column, select the colour of the positioner that corresponds to the appropriate code and dimension of the contact to be crimped.
6. With the CCTP turret in the adjustment position, turn the turret until the colour-coded positioner is aligned with the indicator line. Press the turret until it clicks into the connected position.
7. Refer to the data plate on the CCTP turret. From the column indicating the proper conductor section, determine the number that corresponds to the contact being used.
8. Remove the retaining hook from the crimping tool selector dial. Lift the selector dial and turn it until the selector number is aligned with the indicator (SEL.NO.). Replace the retaining hook (if necessary).

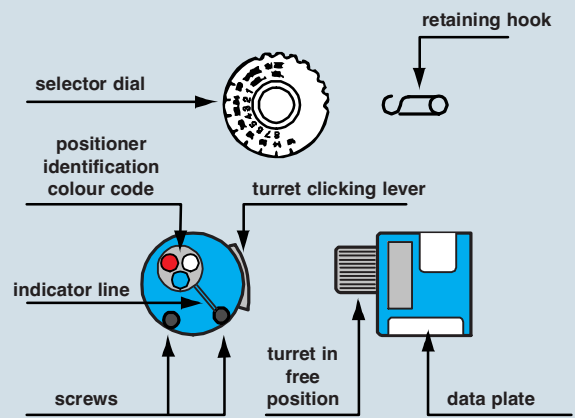

**Crimping instructions**

1. Insert the contact and the prepared conductor through the opening of the indenter in the turret positioner.
2. Tighten the crimping tool handle until the stop gear is released. The tool will return to the open position.
3. Check the position of the crimping on the contact crimping foot. Ideally, the crimping should be between the inspection hole and the top edge of the crimping foot. The head of the contact should not be squared and the inspection hole should be intact.

**Crimping tool maintenance**

No maintenance is required. However, it is good practice to keep the indenter tips free from residual deposits of the coloured band (some types of crimp contacts as per MIL standards are identified by coloured bands in the crimping area) and any other debris. A metal brush may be used for this purpose. The following is strongly recommended:

1. DO NOT immerse the tools in a solution to clean them.
2. DO NOT brush oil in the tools to lubricate them.
3. DO NOT try to disassemble the tool or repair it.

This is a high-precision manual crimping tool and must be used as such. For automatic crimping operations refer to the CCPZP and/or CCPZPA crimping tool models.

**Removing the CCTP turret**

With the crimping tool in the open position, to disassemble the turret, loosen the socket head screws using the 3.5 mm Allen wrench (supplied with the kit). After the threads are released from the support ring, pull off the turret with a straight movement.

**Instructions to check calibration**

The operations to check the crimping tool must be carried out with the selector dial in position 4 and the CCPNP gauge. **ATTENTION! Do not crimp the gauge.**

**Calibration check**

Put the crimping tool in the completely closed position.

“GO” - Insert the end (green) of the gauge as shown (Fig. 1). The gauge must pass freely between the indenter tips.

“NO GO” - Insert the end (red) of the gauge as shown (Fig. 2). The gauge should not pass through the opening.

Gauge	tool selector pos. No.	Ø A ± 0.00254 mm (go) green	Ø B ± 0.00254 mm (no go) red
CCPNP	4	0.991 (mm)	1.118 (mm)

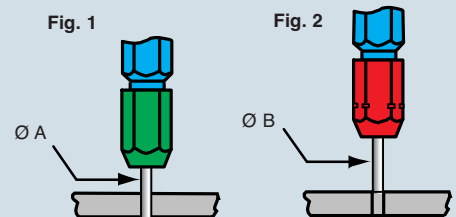



for contacts of insert series:	page:
<b>CX 6/36</b> * ..... (40A)	152
<b>CX 12/2</b> * ..... (40A)	153
<b>MIXO</b> ..... (40A)	165-171

\* the underlined polarities indicate those contacts that require the tools shown in this page

\*\*) On request is possible to supply the pneumatic crimping tool version (part. No. **CXPZP D**), please contact us for further details.

**manual crimping tool \*\*)**  
**turret heads**  
**gauge**



**removal tool**



description	part No.	part No.
crimping tool for <b>40A</b> DANIELS M309 model (turret excluded)	<b>CXPZ D</b>	
turret heads (see note) - for <u>male</u> contacts <b>40A</b> - for <u>female</u> contacts <b>40A</b>	<b>CXTP 40 M</b> <b>CXTP 40 F</b>	
"go / no go" control gauge to verify indenter closure (see note)	<b>CXPNP</b>	
removal tool for the extraction of contacts from the inserts - for <b>40A</b> contacts		<b>CXES</b>

**Notes:**

**Positioning turret**

- An interchangeable and indispensable accessory of the CXPZ D crimping tool, it precisely positions the contact where crimping is performed. Each series of contacts (male or female) requires its own turret.

**"go / no go" control gauge**

- A tool used to periodically check that the crimping tool meets standard requirements.

**CXPNP**

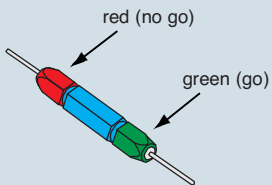

**CXPZ D**

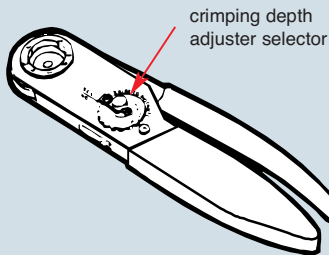

**CXTP 40 M and CXTP 40 F**

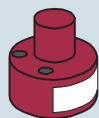

**CXES**

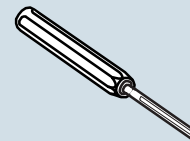

**General specifications**

The CXPZ D crimping tool performed with 8 pressure points. The tool is equipped with a geared mechanism to control the complete crimping cycle.

**The tool must be equipped with an interchangeable turret (CXTP) according to the series of contacts to be crimped.**

**Crimping range**

Wire section:

dimension from 1.5 mm<sup>2</sup> (16 AWG) to 6 mm<sup>2</sup> (10 AWG)

**Caution!**

**The handle of the tool must be in the open position when the turret is installed, disassembled or opened. If not, the turret and the crimping tool may be damaged.**

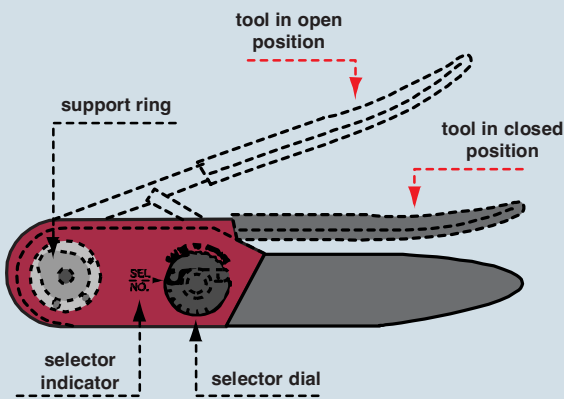

**CXTP turret installation**

1. The crimping tool must be in the open position.
2. Choose the turret to be used, according to the contacts that should be crimped (male or female).
3. Position the previously selected CXTP turret on the support ring located on the crimping tool (matching the special pin on the base of the turret with the corresponding hole on the support ring), aligning the tapped holes with the socket head screws.
4. With the CXTP turret positioned against the support ring, tighten the socket head screws with the 3.5 mm Allen wrench (supplied with the kit).
5. Refer to the data plate on the CXTP turret. From the column indicating the proper conductor section, determine the number that corresponds to the contact being used.
6. Remove the retaining hook from the crimping tool selector dial. Lift the selector dial and turn it until the selector number is aligned with the indicator (SEL.NO.). Replace the retaining hook (if necessary).

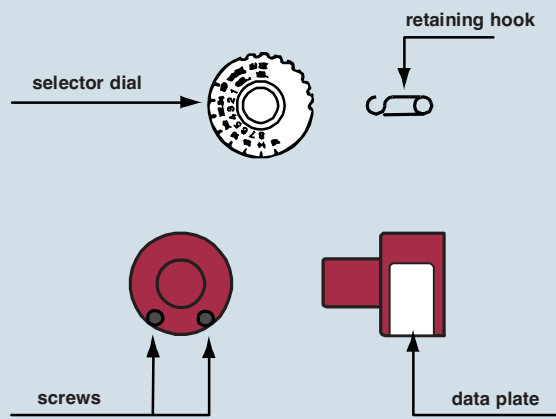

**Crimping instructions**

1. Insert the contact and the prepared conductor through the opening of the indenter in the turret positioner.
2. Tighten the crimping tool handle until the stop gear is released. The tool will return to the open position.
3. Check the position of the crimping on the contact crimping foot. Ideally, the crimping should be between the inspection hole and the top edge of the crimping foot. The head of the contact should not be squared and the inspection hole should be intact.

**Crimping tool maintenance**

No maintenance is required. However, it is good practice to keep the indenter tips free from residual deposits of the coloured band (some types of crimp contacts as per MIL standards are identified by coloured bands in the crimping area) and any other debris. A metal brush may be used for this purpose. The following is strongly recommended:

1. DO NOT immerse the tools in a solution to clean them.
2. DO NOT brush oil in the tools to lubricate them.
3. DO NOT try to disassemble the tool or repair it.

This is a high-precision manual crimping tool and must be used as such.

**Removing the CXPT turret**

With the crimping tool in the open position, to disassemble the turret, loosen the socket head screws using the 3.5 mm Allen wrench (supplied with the kit). After the threads are released from the support ring, pull off the turret with a straight movement.

**Instructions to check calibration**

The operations to check the crimping tool must be carried out with the selector dial in position 4 and the CCPNP gauge. **ATTENTION! Do not crimp the gauge.**

**Calibration check**

Put the crimping tool in the completely closed position.

“GO” - Insert the end (green) of the gauge as shown (Fig. 1).

The gauge must pass freely between the indenter tips.

“NO GO” - Insert the end (red) of the gauge as shown (Fig. 2).

The gauge should not pass through the opening.

Gauge	tool selector pos. No.	Ø A ± 0.00254 mm (go) green	Ø B ± 0.00254 mm (no go) red
CXPNP	4	1.549 (mm)	1.676 (mm)

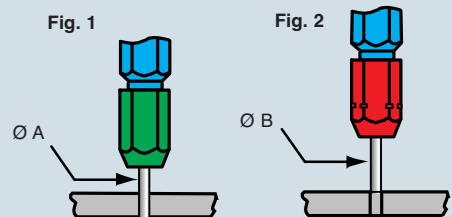

for contacts of insert series:	page:
<b>CD</b> ..... (10A)	45-53
<b>CDD</b> ..... (10A)	59-66
<b>CDC</b> ..... (16A)	73-77
<b>CQ</b> ..... (16A/10A)	69-70
<b>CQE</b> ..... (16A)	80-85
<b>CCE</b> ..... (16A)	94-104
<b>CMCE</b> ..... (16A)	134-146
<b>CX 8/24</b> ..... (16A/10A)	151
<b>CX 6/36</b> ..... (40A/10A)	152
<b>CX 12/2</b> ..... (40A/10A)	153
<b>MIXO</b> .... (40A/16A/10A)	165-184

**manual crimping tool gauge**



**insertion tool removal tools - tip**



description	part No.	part No.
crimping tool for <b>10A, 16A and 40A</b> contacts RENNSTEIG model (turret included)	<b>CCPZ RN</b>	
"go / no go" control gauge to verify indenter closure (see note)	<b>CCPNP RN</b>	
insertion tool for insertion of the contacts into the inserts for crimped contacts up to 0.75 mm <sup>2</sup>		<b>CCINA</b>
removal tools for the extraction of contacts from the inserts - for <b>10A</b> contacts <sup>1)</sup> - for <b>16A</b> contacts <sup>2)</sup> - for <b>40A</b> contacts <sup>3)</sup> and cables Ø < 5 mm - for <b>40A</b> contacts <sup>4)</sup> and cables Ø < 7.5 mm		<b>CCES</b> <b>CQES</b> <b>CXES</b> <b>CXES-10</b>
replacement tip for CCES removal tool		<b>CCPR RN</b>

**Notes:**

- 1) for CQ, CD, CDD, CX inserts (10A auxiliary contacts) and MIXO module (10A)
- 2) for CQ, CQE, CCE, CMCE inserts (excluded 16+2) and MIXO module (16A) for CDC, CMCE (16+2), CX inserts (contacts 16A insert CX 8/24) using a flat 3 mm screwdriver
- 3) for CX inserts (40A contacts) and MIXO module (40A)
- 4) for MIXO module CX 03 4B and contacts 10 mm<sup>2</sup>

**"go / no go" control gauge**

- A tool used to periodically check that the crimping tool meets standard requirements.

**CCPNP RN**

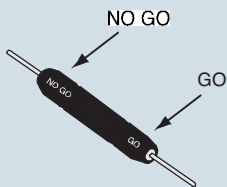

**CCPZ RN**

positioning turret incorporated



**CCINA**

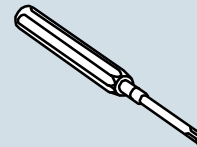

**CCES**

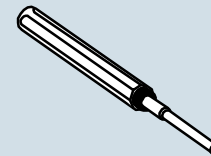

**CCPR RN**

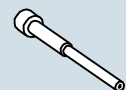

**CQES**

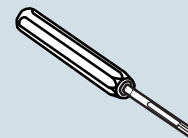

**CXES**

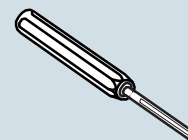



**General specifications**

The CCPZ RN crimping tool crimps with 8 pressure points, obtaining similar results to the prescriptions of standard MIL-C-22520/1. The tool has a geared mechanism for controlling the complete crimping cycle, and houses a positioning turret with 12 positions, three of which can be used for positioning the ILME male and female crimping contacts of series CD (10A max), CC (16A max) and CX (40A max).

**Crimping range**

Wire section: dimension from 0.14 mm<sup>2</sup> (26 AWG) to 6 mm<sup>2</sup> (10 AWG)

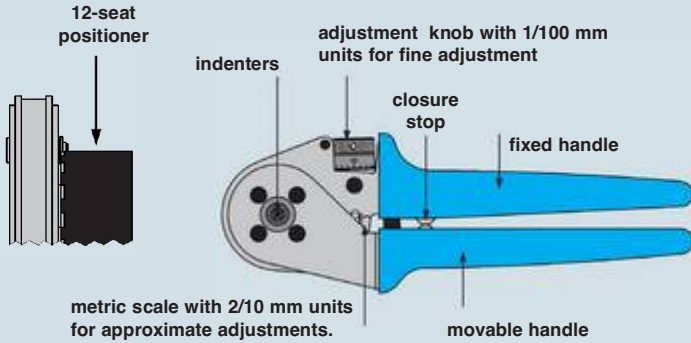

**Description of tool**

Crimping tool components: a first mobile handle, with a precision stop mechanism with teeth and an opening limiting guide; a second fixed handle with metric scale (units of 2/10 mm); an adjustment system with fine step adjustments of 1/100 mm; four indenters; a 12-seat positioner, fully rotating through 360° for accurate positioning of contacts. A reference table engraved on the tool surface provides the positioner (POS) number and crimping depth (SET) to select according to the type and size of the ILME contact (the crimping tool can be set to any crimping depth which may be required by the contact manufacturer).

**Crimping instructions**

The reference matrix on the crimping tool indicates the correct seat of the positioner (POS 1, 2, or 3) to select, and the crimping depth (SET) to adjust for the contact to be crimped. The contact is inserted through the crimper entry hole on the opposite side of the positioner. The contact is closed by closing the handles in the first stop position, in order to prevent the contact coming out off the crimper and to facilitate fitting the conductor in the contact. The precision stop mechanism with teeth ensures consistently precise crimps, by forcing the crimper to close completely and finish the crimping cycle before the crimper can be re-opened.

**Adjustment tool**

**Positioner seat = 1**

CDMA/D (male) CCFA/D (female)	Section (mm <sup>2</sup> )	Crimp depth (mm)
0.3	0.14	1.3
	0.25	
	0.37	
0.5	0.5	1.55
0.7	0.75	1.55
1.0	1.0	1.55
1.5	1.5	1.55
2.5	2.5	1.55

**Positioner seat = 2**

CCMA/D (male) CCFA/D (female)	Section (mm <sup>2</sup> )	Crimp depth (mm)
0.5	0.5	1.55
0.7	0.75	1.55
1.0	1.0	1.55
1.5	1.5	1.8
2.5	2.5	1.8
4.0	4	2.0

**Positioner seat = 3**

CXMA/D (male) CXFA/D (female)	Section (mm <sup>2</sup> )	Crimp depth (mm)
1.5	1.5	1.55
2.5	2.5	1.8
4.0	4	2.0
6.0	6	2.5
10	10	2.3

**Adjustment of crimp depth**

Crimp depth to be adjusted as follows: the adjustment knob should be turned clockwise to reduce crimping depth, and anti-clockwise to increase it.

**Adjustment tolerances:**

- 1 scale mark on the knob = adjustment of 1/100 mm (0.01 mm)
- 1 complete rotation of knob = adjustment of 2/10 mm (0.2 mm, this indication can be read on the knob and on the approximate scale)
- 5 knob rotations = adjustment of 1.0 mm (this indication can be read on the scale)

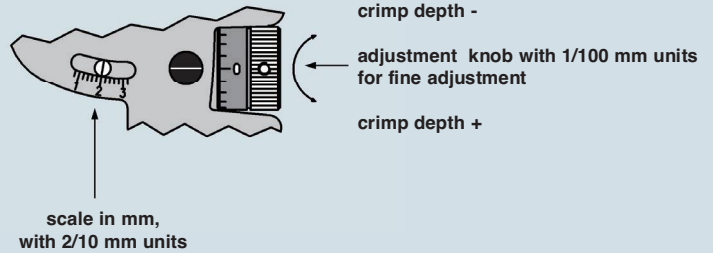

**Maintenance and repair**

Keep the crimping tool clean and store it correctly when not in use. The joints need to be lubricated periodically, and the pin stop circular clips must always stay in position. This is a high precision crimping tool and must be used as such.

**Calibration check**

The crimping tool is adjusted in the manufacturer's plant. To ensure correct calibration, we advise you to check the tool with a gauge every working day. This is easily done with the CCPNP RN cylindrical gauge in the 2.0 mm Ø position. **ATTENTION! Do not crimp the gauge.** Crimping depth of 2 mm can be adjusted with the adjustment knob (scale marked on "2", screw indicator on "0" as shown in the above figure).

Put the crimping tool in the completely position.

**"GO"** - Insert the end of the gauge as shown (Fig. 1).

The gauge must pass freely between the indenter tips.

**"NO GO"** - Insert the end of the gauge as shown (Fig. 2).

The gauge should not pass through the opening.

Gauge	tool selector pos. No.	Ø A GO	Ø B NO GO
CCPNP RN	2	1.94 (mm)	2.06 (mm)

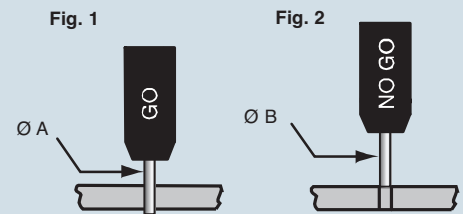

for contacts of insert series: page:

**MIXO** (CI contacts, 8 poles) 181 and 446  
**MIXO** (CI contacts, 25 poles) 179

**manual crimping tool  
 turret head**



**NEW**

**insertion / removal tool**



**NEW**

description

part No.

part No.

crimping tool for **CI** contacts  
 DANIELS AFM8 model (turret excluded)

**CIPZ D**

turret head  
 - for **CI** contacts (CIFD and CIMD series)

**CITP D**

insertion tool:  
 for insertion of the contacts into the inserts, and  
 removal tool:  
 for the extraction of contacts from the inserts  
 - for **CI** contacts (CIFD and CIMD series)

**CIES**



**N.B.:**  
**CITP D** turret head (to be ordered separately)

<p>for contacts of insert series:</p> <p><b>MIXO</b> ..... (D-SUB)</p>	<p>page: 186</p> <p><b>manual crimping tool turret head</b></p>  <p><b>NEW</b></p>	<p><b>insertion / removal tool</b></p>  <p><b>NEW</b></p>
<p>description</p>	<p>part No.</p>	<p>part No.</p>
<p>crimping tool for <b>5A</b> contacts DANIELS AFM8 model (turret excluded)</p>	<p><b>CIPZ D</b></p>	
<p>turret head - for <b>5A</b> D-SUB contacts (CIVFD and CIVMD series)</p>	<p><b>CIVTP D</b></p>	
<p>insertion tool: for insertion of the contacts into the inserts, and removal tool: for the extraction of contacts from the inserts - for <b>5A</b> D-SUB contacts (CIVFD and CIVMD series)</p>		<p><b>CIVES</b></p>



**N.B.:**  
CIVTP D turret head (to be ordered separately)

for contacts of insert series:  
**MIXO** ..... (70A)

page:  
 164

**manual crimping tool  
 crimp matrixes**



**removal tool**



**AVAILABLE**

description	part No.	part No.
crimping tool for <b>70A CX7</b> series contacts basic tool mod. CEMBRE HT 45 with built-in ILME locator CX7PZ LOC (excluding crimp matrixes)	<b>CX7PZ</b>	
crimp matrixes - for CX7 contacts with 10 mm <sup>2</sup> (AWG 8 - 7) section - for CX7 contacts with 16 mm <sup>2</sup> (AWG 6 - 5) section - for CX7 contacts with 25 mm <sup>2</sup> (AWG 4 - 3) section	<b>CGD 10 C</b> <b>CGD 16 C</b> <b>CGD 25 C</b>	
removal tool		<b>C7ES</b>

## General specifications

The **CX7PZ** crimping tool are a hydraulically operated tool suitable for manually crimping **ILME CX7** series (70A max) removable crimp contacts which may be used in **MIXO** series type **CX7**.

By using a suitable, hexagonal footprint crimp matrix pair, these pliers allow crimped connections to be made which conform to the highest quality standards.

The main features of these pliers are listed below:

- Scope of application: suitable for crimping wire terminals for up to 150 mm<sup>2</sup> flexible copper wires.
- Force developed: 50 kN (6 tons)
- Nominal operating pressure: 600 bar (8.600psi)
- Dimensions: length 346 mm (13.6")
  - width (locked moving handle) 130 mm (5.1")
  - width (free moving handle) 250 mm (9.8")
- Weight: (without matrixes and without ILME locator) 2.0kg (4.4lbs)
- Recommended oil: AGIP ARNICA 32 or SHELL TELLUS OIL TX 32 or equivalent
- Other features: please read the user and maintenance manual supplied with the tool.

The pliers are equipped with a locator specifically designed for ILME CX7 series crimp contacts already fitted on the moving part of the pliers head by means of the Allen screw provided.

This **CX7PZ LOC** locator is available on request if it needs replacing.

**NOTE:** It is also possible to use the CX7PZ pliers with the CG 100A and CY 200A contact series, by simply fitting the CGPZ LOC locator with the appropriate crimping matrixes CGD 16 C, CGD 25 C or CGD 35C (for CG contacts 100A) or CYPZ LOC locator and crimping matrixes CGD 25 C, CYD 35 C, CYD 50 C, CYD 70 C (for CY contacts 200A) to be purchased separately.

## User instructions

### 1) Preliminary operations

According to requirements, the pliers can be fitted with one or more pairs of crimp matrixes selected from the matrixes listed in the catalogue, to crimp the contacts shown in the table below:

article ref.	punching	contacts	mm <sup>2</sup>	AWG min (mm <sup>2</sup> )	AWG max (mm <sup>2</sup> )
<b>CGD 10 C</b>	ME 2	<b>CX7MA 10, CX7FA 10</b>	10	8 (8.4)	7 (10.6)
<b>CGD 16 C</b>	ME 3	<b>CX7MA 16, CX7FA 16</b>	16	6 (13.3)	5 (16.8)
<b>CGD 25 C</b>	ME 5	<b>CX7MA 25, CX7FA 25</b>	25	4 (21.2)	3 (26.7)

### NOTE:

The **CX7** series crimp contacts are only suitable for crimping flexible copper wires featuring a nominal section shown in the table with the crimp matrixes shown in the table. Any contacts – wires – matrixes combination which does not conform to these instructions is not physically possible (ex: using 35 mm<sup>2</sup> contacts with CGD 25 C matrixes is not possible because the pliers head would not close) or produces non conforming crimped connections or not usable in the **MIXO** series **CX7** type connector modules.

Open the tool head by moving the matrix supporting hook (22) outwards until the matrix support (21) is released.

With reference to Figures 1 and 2, select a pair of matrixes suitable to the type of contact and insert them in the housings: one in the matrix support (21), the other one in the matrix pusher support (26).

(NB: the two matrixes of each pair are the same).

Insert the contact by resting it in the locator with the tip forward, then close the head. The contact crimp housing will be accessible in the mouth between the matrixes.

Remove the moving handle (36) by removing the handle locking belt from the handle. Before carrying out the next operations, make sure the head is fully closed to avoid damages.

The pliers head can rotate by 180° in relation to the body, thus allowing the operator to work in the most comfortable position.

**WARNING: do not force the head by trying to rotate it when the tool is under pressure.**

### 2) Closing the dies

If possible, rest the pliers head on a work top, then move the moving handle to start moving the matrixes closer to the contact, then carry on moving them until the contact is locked between the matrixes.

Push the correctly stripped and suitable long (15 mm) wire all the way in the contact crimp housing by carefully checking that the braids are fully compacted, are not damaged and, above all, are all fully inserted.

Correctly pushing the contact in the locator ensures that the matrixes are exactly in the right area to compress (the contact crimp shaft centre).

Make sure that the locator is free from any residue which would alter the position of the contact.

### 3) Crimping

Continue to operate the moving handle (pumping): the piston will gradually move forward until the matrixes come into contact.

Continue the pumping action until the maximum pressure valve clicks in.

### 4) Releasing the dies

Fully press the pressure release lever (50) located on the pliers pumping body until the piston goes back and the matrixes open.

To remove the crimped contact, re-open the pliers head.

### 5) Storage

Fully return the piston as described in paragraph 4, then lock the moving handle in position by using the belt provided.

### Cleaning and maintenance

The tool is very sturdy and does not require any special care; a correct operation is ensured by following a few simple precautions.

The tool is supplied with a user and maintenance manual, which gives all detailed instructions. Read this manual before use.

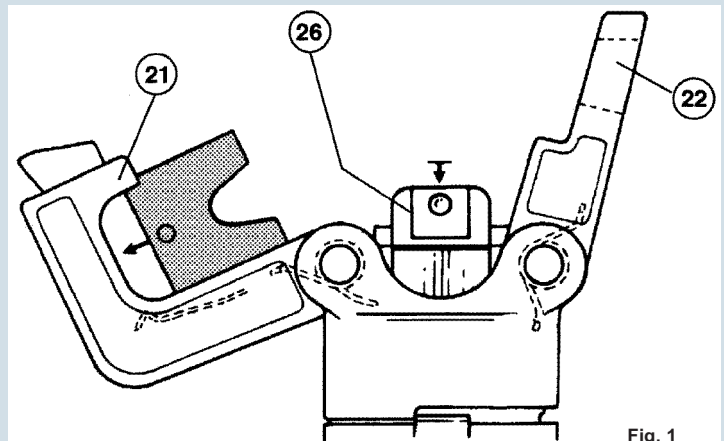

Fig. 1

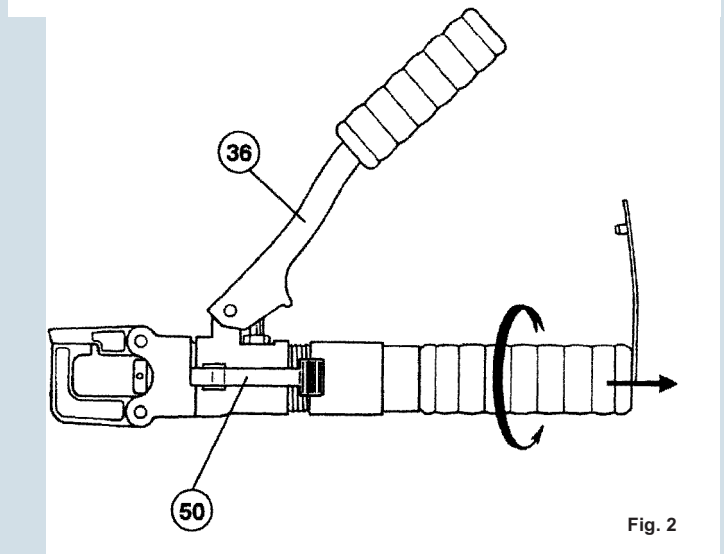

Fig. 2

CGPZ VLG carrying case



for CX7PZ \* crimping tool  
 - dimensions 445 x 290 x h 95 mm  
 - weight 1.2 kg  
 houses 20 pairs of matrixes

\* to store the CX7PZ crimping tool inside the carrying case, turn the pliers head by 180° so that the locator becomes visible.





## General specifications

The **CGPZ** crimping tool are a hydraulically operated tool suitable for manually crimping **ILME CG** series (100A max) removable crimp contacts which may be used in **MIXO** series type **CG** (page 3) modular inserts and **CGT 16** adaptor to connect 16 mm<sup>2</sup> flexible safety wires to the largest of MIXO series frame earth terminals.

By using a suitable, hexagonal footprint crimp matrix pair, these pliers allow crimped connections to be made which conform to the highest quality standards.

The main features of these pliers are listed below:

- Scope of application: suitable for crimping wire terminals for up to 150 mm<sup>2</sup> flexible copper wires.
- Force developed: 50 kN (6 tons)
- Nominal operating pressure: 600 bar (8.600psi)
- Dimensions: length 346 mm (13.6")
  - width (locked moving handle) 130 mm (5.1")
  - width (free moving handle) 250 mm (9.8")
- Weight: (without matrixes and without ILME locator) 2.0kg (4.4lbs)
- Recommended oil: AGIP ARNICA 32 or SHELL TELLUS OIL TX 32 or equivalent
- Other features: please read the user and maintenance manual supplied with the tool.

The pliers are equipped with a locator specifically designed for ILME CG series crimp contacts already fitted on the moving part of the pliers head by means of the Allen screw provided.

This **CGPZ LOC** locator is available on request if it needs replacing.

**WARNING:** For crimping the CGT 16 adaptor, the crimp locating operation must be carried out by the user.

## User instructions

### 1) Preliminary operations

According to requirements, the pliers can be fitted with one or more pairs of crimp matrixes selected from the matrixes listed in the catalogue, to crimp the contacts shown in the table below:

article ref.	punching	contacts	mm <sup>2</sup>	AWG min (mm <sup>2</sup> )	AWG max (mm <sup>2</sup> )
<b>CGD 16 C</b>	ME 3	<b>CGMA 16, CGFA 16</b>	16	6	5
		<b>CGT 16</b>		(13.3)	(16.8)
<b>CGD 25 C</b>	ME 5	<b>CGMA 25, CGFA 25</b>	25	4	3
				(21.2)	(26.7)
<b>CGD 35 C</b>	ME 7	<b>CGMA 35, CGFA 35</b>	35	-	2 (33.6)

**NOTE:** The CG series crimp contacts are only suitable for crimping flexible copper wires featuring a nominal section shown in the table with the crimp matrixes shown in the table. Any contacts – wires – matrixes combination which does not conform to these instructions is not physically possible (ex: using 35 mm<sup>2</sup> contacts with CGD 25 C matrixes is not possible because the pliers head would not close) or produces non conforming crimped connections or not usable in the MIXO series CG type connector modules.

Open the tool head by moving the matrix supporting hook (22) outwards until the matrix support (21) is released.

With reference to Figures 1 and 2, select a pair of matrixes suitable to the type of contact and insert them in the housings: one in the matrix support (21), the other one in the matrix pusher support (26). (NB: the two matrixes of each pair are the same). Insert the contact by resting it in the locator with the tip forward, then close the head. The contact crimp housing will be accessible in the mouth between the matrixes.

**NOTE:** for **CGMA 35** and **CGFA 35** contacts, and their corresponding **CGD 35 C** matrix pair, the contact may be inserted even after closing the head.

Remove the moving handle (36) by removing the handle locking belt from the handle. Before carrying out the next operations, make sure the head is fully closed to avoid damages.

The pliers head can rotate by 180° in relation to the body, thus allowing the operator to work in the most comfortable position.

**WARNING:** do not force the head by trying to rotate it when the tool is under pressure.

### 2) Approaching the matrixes

If possible, rest the pliers head on a work top, then move the moving handle to start moving the matrixes closer to the contact, then carry on moving them until the contact is locked between the matrixes.

Push the correctly stripped and suitable long (15 mm) wire all the way in the contact (or the CGT adaptor) crimp housing by carefully checking that the braids are fully compacted, are not damaged and, above all, are all fully inserted.

Correctly pushing the contact in the locator ensures that the matrixes are exactly in the right area to compress (the contact crimp shaft centre). Make sure that the locator is free from any residue which would alter the position of the contact.

For crimping the CFT 15 earth adaptor, manually locate the area to be crimped between the matrixes. If necessary, re-open the matrixes by following the instructions described in paragraph 4 and reposition the contact.

### 3) Crimping

Continue to operate the moving handle (pumping): the piston will gradually move forward until the matrixes come into contact. Continue the pumping action until the maximum pressure valve clicks in.

### 4) Releasing the matrixes

Fully press the pressure release lever (50) located on the pliers pumping body until the piston goes back and the matrixes open.

To remove the crimped contact, re-open the pliers head.

### 5) Storage

Fully return the piston as described in paragraph 4, then lock the moving handle in position by using the belt provided.

### Cleaning and maintenance

The tool is very sturdy and does not require any special care; a correct operation is ensured by following a few simple precautions.

The tool is supplied with a user and maintenance manual, which gives all detailed instructions. Read this manual before use.

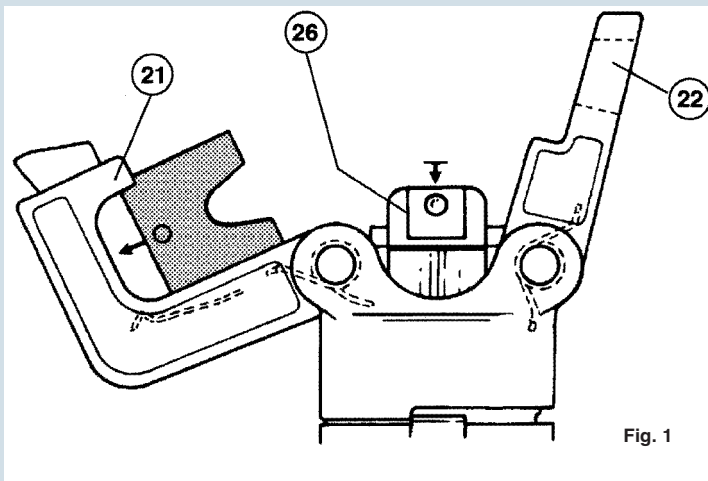

Fig. 1

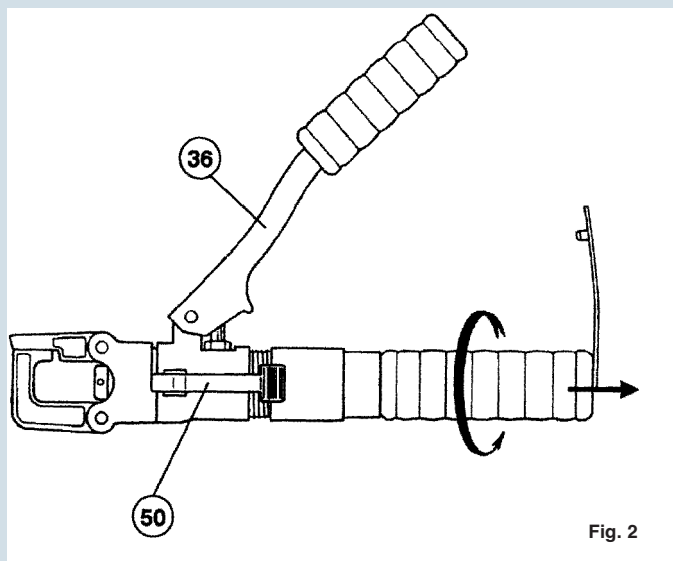

Fig. 2

for contacts of insert series: page  
**MIXO** ..... (200A) 160-161

**manual crimping tool  
 crimp matrixes**



description	part No.
crimping tool for <b>200A CY</b> series contacts basic tool mod. CEMBRE HT 45 complete with removable ILME locator CYPZ LOC for CY contacts (excluding crimp matrixes) *	<b>CYPZ</b>
crimp matrixes - for CY contacts section 16 mm <sup>2</sup> (AWG 6) - for CY contacts section 25 mm <sup>2</sup> (AWG 4) and section 35 mm <sup>2</sup> (AWG 2) - for CY contacts section 50 mm <sup>2</sup> (AWG 1) - for CY contacts section 70 mm <sup>2</sup> (AWG 2/0)	<b>CGD 25 C</b> <b>CYD 35 C</b>  <b>CYD 50 C</b> <b>CYD 70 C</b>

\* It is also possible to use the CYPZ crimping tool with the CG 100A contact series, by simply fitting the CGPZ LOC with the appropriate crimp matrixes CGD 16 C, CGD 25 C or CGD 35 C purchased separately.

## General specifications

The CYPZ crimping tool are a hydraulically operated tool suitable for manually crimping ILME CY series (200A max) removable crimp contacts which may be used in MIXO series type CY.

By using a suitable, hexagonal footprint crimp matrix pair, these pliers allow crimped connections to be made which conform to the highest quality standards.

The main features of these pliers are listed below:

- Scope of application: suitable for crimping wire terminals for up to 150 mm<sup>2</sup> flexible copper wires.
- Force developed: 50 kN (6 tons)
- Nominal operating pressure: 600 bar (8.600psi)
- Dimensions: length 346 mm (13.6")
  - width (locked moving handle) 130 mm (5.1")
  - width (free moving handle) 250 mm (9.8")
- Weight: (without matrixes and without ILME locator) 2.0kg (4.4lbs)
- Recommended oil: AGIP ARNICA 32 or SHELL TELLUS OIL TX 32 or equivalent
- Other features: please read the user and maintenance manual supplied with the tool.

The pliers are equipped with a locator specifically designed for ILME CY series crimp contacts already fitted on the moving part of the pliers head by means of the Allen screw provided.

This CYPZ LOC locator is available on request if it needs replacing.

## User instructions

### 1) Preliminary operations

According to requirements, the pliers can be fitted with one or more pairs of crimp matrixes selected from the matrixes listed in the catalogue, to crimp the contacts shown in the table below:

article ref.	punching	contacts	mm <sup>2</sup>	AWG (mm <sup>2</sup> )
CGD 25 C	ME 5	CYMA 16, CYFA 16	16	6 (13.3)
CYD 35 C	ME 9	CYMA 25, CYFA 25	25	4 (21,2)
		CYMA 35, CYFA 35	35	2 (33.6)
CYD 50 C	ME 12	CYMA 50, CYFA 50	50	1 (42.4)
CYD 70 C	ME 17	CYMA 70, CYFA 70	70	2/0 (67.4)

**NOTE:** The CY series crimp contacts are only suitable for crimping flexible copper wires featuring a nominal section shown in the table with the crimp matrixes shown in the table. Any contacts – wires – matrixes combination which does not conform to these instructions is not physically possible (ex: using 35 mm<sup>2</sup> contacts with CGD 25 C matrixes is not possible because the pliers head would not close) or produces non conforming crimped connections or not usable in the MIXO series CY type connector modules.

Open the tool head by moving the matrix supporting hook (22) outwards until the matrix support (21) is released.

With reference to Figures 1 and 2, select a pair of matrixes suitable to the type of contact and insert them in the housings: one in the matrix support (21), the other one in the matrix pusher support (26). (NB: the two matrixes of each pair are the same). Insert the contact by resting it in the locator with the tip forward, then close the head. The contact crimp housing will be accessible in the mouth between the matrixes.

Remove the moving handle (36) by removing the handle locking belt from the handle. Before carrying out the next operations, make sure the head is fully closed to avoid damages.

The pliers head can rotate by 180° in relation to the body, thus allowing the operator to work in the most comfortable position.

**WARNING: do not force the head by trying to rotate it when the tool is under pressure.**

### 2) Closing the dies

If possible, rest the pliers head on a work top, then move the moving handle to start moving the matrixes closer to the contact, then carry on moving them until the contact is locked between the matrixes.

Push the correctly stripped and suitable long (15 mm) wire all the way in the contact crimp housing by carefully checking that the braids are fully compacted, are not damaged and, above all, are all fully inserted.

Correctly pushing the contact in the locator ensures that the matrixes are exactly in the right area to compress (the contact crimp shaft centre).

Make sure that the locator is free from any residue which would alter the position of the contact.

### 3) Crimping

Continue to operate the moving handle (pumping): the piston will gradually move forward until the matrixes come into contact. Continue the pumping action until the maximum pressure valve clicks in.

### 4) Releasing the dies

Fully press the pressure release lever (50) located on the pliers pumping body until the piston goes back and the matrixes open.

To remove the crimped contact, re-open the pliers head.

### 5) Storage

Fully return the piston as described in paragraph 4, then lock the moving handle in position by using the belt provided.

## Cleaning and maintenance

The tool is very sturdy and does not require any special care; a correct operation is ensured by following a few simple precautions.

The tool is supplied with a user and maintenance manual, which gives all detailed instructions.

Read this manual before use.

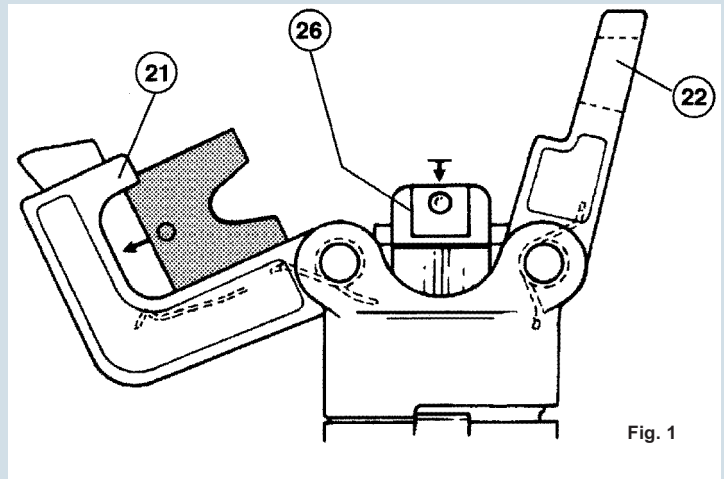

Fig. 1

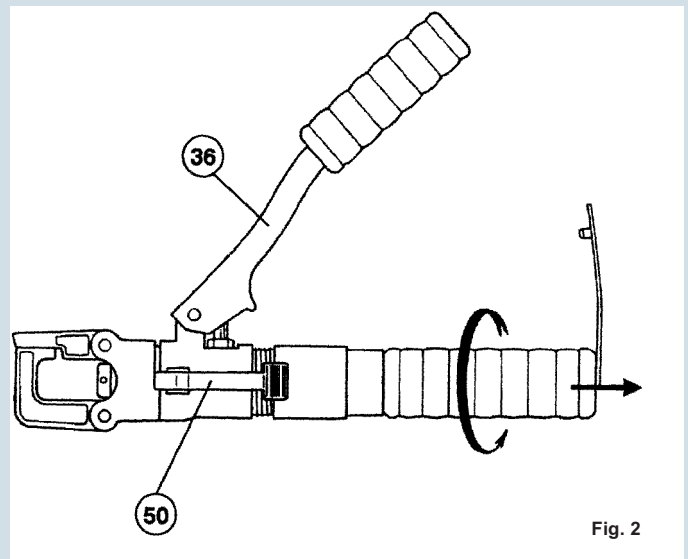

Fig. 2

for contacts of insert series:	page
<b>CD</b> ..... (10A)	45-53
<b>CDD</b> ..... (10A)	59-66
<b>CDC</b> ..... (16A)	73-77
<b>CQ</b> ..... (16A/10A)	69-70
<b>CQE</b> ..... (16A)	80-85
<b>CCE</b> ..... (16A)	94-104
<b>CMCE</b> ..... (16A)	134-146
<b>CX 8/24</b> ..... (16A/10A)	151
<b>CX 6/36</b> * ..... (10A)	152
<b>CX 12/2</b> * ..... (10A)	153
<b>MIXO</b> ..... (16A/10A)	172-1184

\* the underlined polarities indicate those contacts that require the tools shown in this page

**pneumatic crimping tool  
turret heads - gauge**



**insertion tool  
removal tools - tip**



description	part No.	part No.
pneumatic crimping tool for <b>10A</b> and <b>16A</b> contacts model DANIELS WA27F (turret excluded)	<b>CCPZP</b>	
turret heads (see note) - for <b>10A</b> contacts (CDF and CDM series) - for <b>16A</b> contacts (CCF and CCM series)	<b>CCTP 10</b> <b>CCTP 16</b>	
support for CCPZP pneumatic crimping tool	<b>CCSPZP</b>	
pneumatic foot valve	<b>CCVPP</b>	
"go / no go" control gauge to verify indenter closure (see note)	<b>CCPNP</b>	
insertion tool for insertion of the contacts into the inserts for crimped contacts up to 0.75 mm <sup>2</sup>		<b>CCINA</b>
removal tools for the extraction of contacts from the inserts - for <b>10A</b> contacts <sup>1)</sup> - for <b>16A</b> contacts <sup>2)</sup>		<b>CCES</b> <b>CQES</b>
replacement tip for CCES removal tool		<b>CCPR RN</b>

**Notes:**

- 1) for CQ, CD, CDD, CX inserts (10A auxiliary contacts) and MIXO module (10A)
- 2) for CQ, CQE, CCE, CMCE inserts (excluded 16+2) and MIXO module (16A) for CDC, CMCE (16+2), CX inserts (contacts 16A insert CX 8/24) using a flat 3 mm screwdriver

**Positioning turret**

conforms to international standard MIL-C-22520/1  
- An interchangeable and indispensable accessory of the CCPZP crimping tool, it precisely positions the contact where crimping is performed. Each series of contacts requires its own turret.

**"go / no go" control gauge**

conforms to international standard MIL-C-22520/3  
- A tool used to periodically check that the crimping tool meets standard requirements.

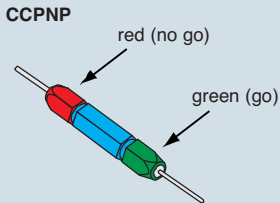

**CCPZP**

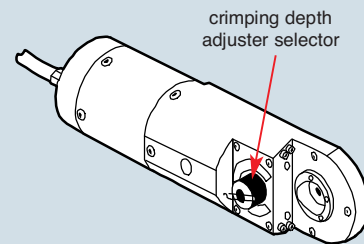

**CCTP**

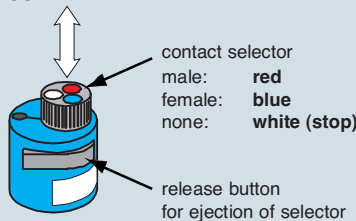

**CCSPZP**

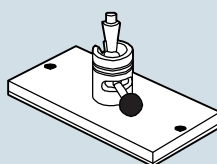

**CCVPP**

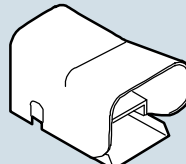

**CCINA**

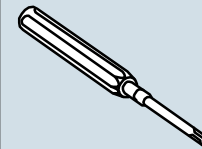

**CCES**

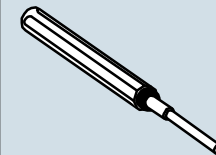

**CCPR RN**

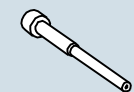

**CQES**

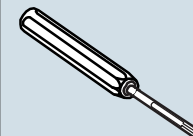

crimping tools

**General specifications**

This is the pneumatic version of the crimping tool. Crimping is performed with 8 pressure points. The tool is equipped with a geared mechanism to control the complete crimping cycle.

**The tool must be equipped with an interchangeable turret (CCTP) according to the series of contacts to be crimped.**

It is possible to use a hand valve (located on the crimping tool) or a foot valve (optional). The tool operating pressure is  $5.5 \div 8.3$  bar. It is recommended to utilise a lubrication, adjustment and air filtering unit.

**Crimping range**

Wire section: dimension from 0.12 mm<sup>2</sup> (26 AWG) to 4 mm<sup>2</sup> (12 AWG).

**Operation with foot valve (optional)**

Connect the foot valve between the compressed air source and the tool air inlet.

Lower the hand valve and stop it in the lowered position with the stop screw (A) using a 1.5 mm Allen wrench.

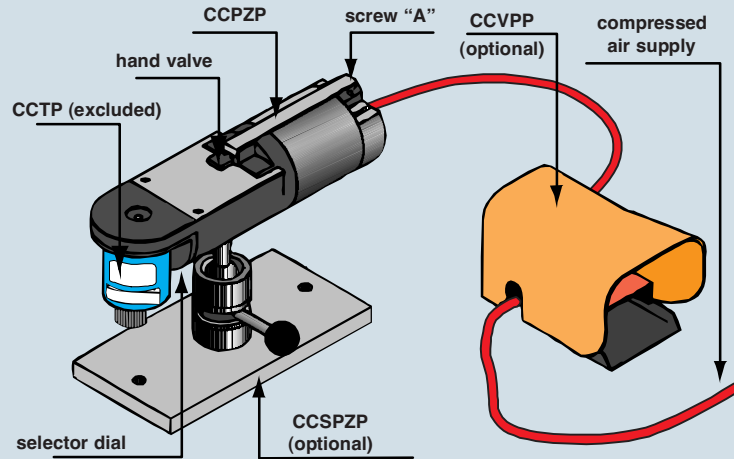

**Checking the crimping complete cycle control mechanism**

Correct operation can be checked based on the following procedure:

1. Install a CCTP turret.
2. Reduce the pressure to 1 bar.
3. Using a contact that corresponds to the installed turret, with size 0.5, and a wire with section 0.5 mm<sup>2</sup>, use the crimping instructions, referring to the crimping instructions. The indenters will not reach the fully closed position and the contact will be internally blocked if the geared mechanism is operating correctly.
4. To release the partially crimped contact, increase the air pressure of the line to  $5.5 \div 8.3$  bar and again use the crimping tool. It will then complete the crimping, allowing the indenters to return to the fully open position.

**Crimping instructions**

1. Insert the contact and the prepared conductor through the opening of the indenter in the turret positioner.
2. Activate the hand valve or the optional foot valve. Once crimping has been completed, the tool will return to the open position.
3. Check the position of the crimping on the contact crimping foot. Ideally, the crimping should be between the inspection hole and the top edge of the crimping foot. The head of the contact should not be squared and the inspection hole should be intact.

**Crimping tool maintenance**

No maintenance is required. However, it is good practice to keep the indenter tips free from residual deposits of the coloured band (some types of crimp contacts as per MIL standards are identified by coloured bands in the crimping area) and any other debris. A metal brush may be used for this purpose.

The following is strongly recommended:

1. DO NOT immerse the tools in a solution to clean them.
2. DO NOT brush oil in the tools to lubricate them.
3. DO NOT try to disassemble the tool or repair it.

This is a high-precision crimping tool and must be used as such.

**CCTP turret installation**

1. Position the previously selected CCTP turret on the support ring located on the crimping tool (matching the special pin on the base of the turret with the corresponding hole on the support ring), aligning the tapped holes with the socket head screws.
2. With the CCTP turret positioned against the support ring, tighten the socket head screws with the 3.5 mm Allen wrench (supplied with the kit).
3. Refer to the data plate on the CCTP turret. From the colour code column, select the colour of the positioner that corresponds to the appropriate code and dimension of the contact to be crimped.
4. With the CCTP turret in the adjustment position, turn the turret until the colour-coded positioner is aligned with the indicator line. Press the turret until it clicks into the connected position.
5. Refer to the data plate on the CCTP turret. From the column indicating the proper conductor section, determine the number that corresponds to the contact being used.
6. Remove the retaining hook from the crimping tool selector dial. Lift the selector dial and turn it until the selector number is aligned with the indicator (SEL.NO.). Replace the retaining hook (if necessary).

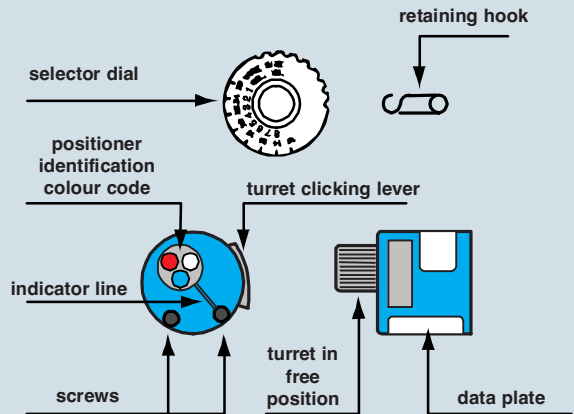

**Removing the CCTP turret**

With the crimping tool in the open position, to disassemble the turret, loosen the socket head screws using the 3.5 mm Allen wrench (supplied with the kit). After the threads are released from the support ring, pull off the turret with a straight movement.

**Releasing a partially crimped contact**

To release a partially crimped contact, do the following:

1. Increase the air pressure to 8.5 bar and use the crimping tool. If the increase in air pressure does not release the contact, do the following.
2. Turn the selector dial clockwise to the highest lockable setting (the selector dial must be in the blocked position before continuing). Use the crimping tool.
3. If it does not release after several attempts, contact the ILME offices.

**Instructions to check calibration**

The operations to check the crimping tool must be carried out with the selector dial in position 4 and the CCPNP gauge. **CAUTION! Do not crimp the gauge.**

**Calibration check**

Put the crimping tool in the completely closed position.

“GO” - Insert the end (green) of the gauge as shown (Fig. 1). The gauge must pass freely between the indenter tips.

“NO GO” - Insert the end (red) of the gauge as shown (Fig. 2). The gauge should not pass through the opening.

Gauge	tool selector pos. No.	Ø A ± 0.00254 mm (go) green	Ø B ± 0.00254 mm (no go) red
CCPNP	4	0.991 (mm)	1.118 (mm)

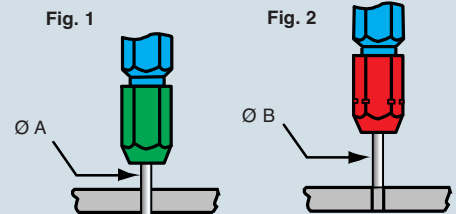

for contacts of insert series:	page
<b>CD</b> ..... (10A)	45-53
<b>CDD</b> ..... (10A)	59-66
<b>CDC</b> ..... (16A)	73-77
<b>CQ</b> ..... (16A/10A)	69-70
<b>CQE</b> ..... (16A)	80-85
<b>CCE</b> ..... (16A)	94-104
<b>CMCE</b> ..... (16A)	134-146
<b>CX 8/24</b> ..... (10A/16A)	151
<b>CX 6/36</b> * ..... (10A)	152
<b>CX 12/2</b> * ..... (10A)	153
<b>MIXO</b> ..... (10A/16A)	172-1184

\* the underlined polarities indicate those contacts that require the tools shown in this page

## pneumatic crimping tool with automatic positioner - inserts - gauge

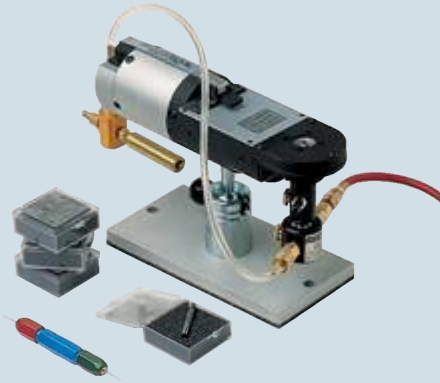

## insertion tool removal tools - tip



description	part No.	part No.
crimping tool with automatic positioner model DANIELS WA27FAP (inserts excluded)	<b>CCPZPA</b>	
positioner inserts (see note) - male contacts <b>10A</b> (CDM series) - female contacts <b>10A</b> (CDF series) - male contacts <b>16A</b> (CCM series) - female contacts <b>16A</b> (CCF series)	<b>CCTPADM</b> <b>CCTPADF</b> <b>CCTPACM</b> <b>CCTPACF</b>	
"go / no go" control gauge to verify indenter closure (see note)	<b>CCPNP</b>	
insertion tool for insertion of the contacts into the inserts for crimped contacts up to 0.75 mm <sup>2</sup>		<b>CCINA</b>
removal tools for the extraction of contacts from the inserts - for <b>10A</b> contacts <sup>1)</sup> - for <b>16A</b> contacts <sup>2)</sup>		<b>CCES</b> <b>CQES</b>
replacement tip for CCES removal tool		<b>CCPR RN</b>

### Notes:

- for CQ, CD, CDD, CX inserts (10A auxiliary contacts) and MIXO module (10A)
- for CQ, CQE, CCE, CMCE inserts (excluded 16+2) and MIXO module (16A) for CDC, CMCE (16+2), CX inserts (contacts 16A insert CX 8/24) using a flat 3 mm screwdriver

### Positioner inserts

- Interchangeable and indispensable accessories of the CCPZPA crimping tool precisely position the contact where crimping is performed. Each contact requires its own positioner insert selected according to the type of contact (10A or 16A) and the kind (male or female).

### "go / no go" control gauge

conforms with international standard MIL-C-22520/3  
- A tool used to periodically check that the crimping tool meets standard requirements.

### CCPNP

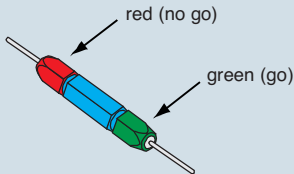

### CCPZPA

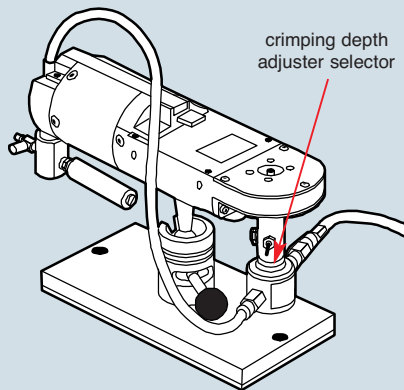

### CCTPADM and CCTPADF CCTPACM and CCTPACF

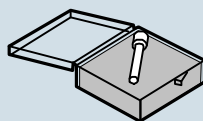

### CCINA

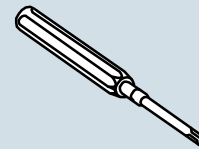

### CCES

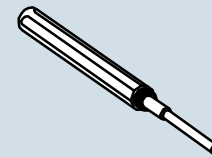

### CQES

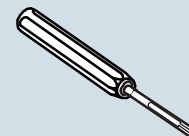

### CCPR RN

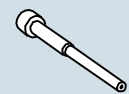



**General specifications**

This is the pneumatic version of the manual crimping tool. Crimping is performed with 8 pressure points. The tool is equipped with a geared mechanism to control the complete crimping cycle.

Thanks to the automatic positioner it is possible to crimp simply by inserting the uncrimped contact + wire into the tool crimping cavity.

**It is also necessary to order the interchangeable positioner inserts relative to the series of contacts to be crimped.**

The tool operating pressure is  $5.5 \div 8.3$  bar. It is recommended to utilise a lubrication, adjustment and air filtering unit.

**Crimping range**

Wire section: dimension from  $0.12 \text{ mm}^2$  (26 AWG) to  $4 \text{ mm}^2$  (12 AWG).

Fig. A (complete crimping tool)

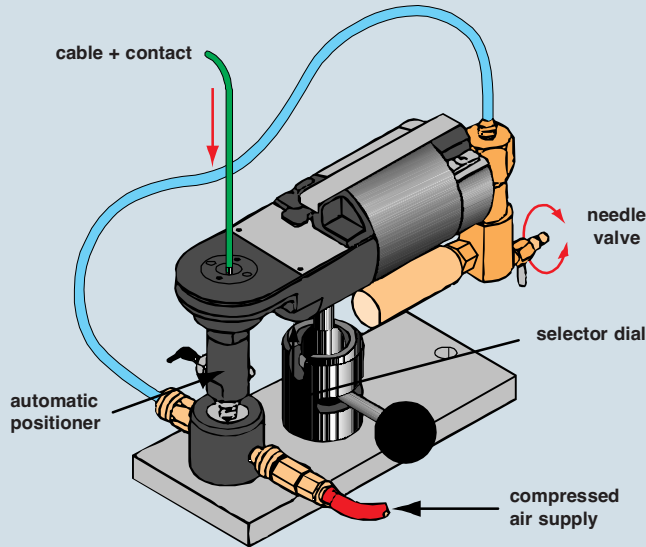

**Checking the crimping complete cycle control mechanism**

Correct operation can be checked based on the following procedure:

1. Reduce the pressure to 1 bar.
2. Using a contact that corresponds to the installed positioner, with size 0.5, and a wire with section  $0.5 \text{ mm}^2$ , use the crimping tool, referring to the crimping instructions. The indenters will not reach the fully closed position and the contact will be internally blocked if the geared mechanism is operating correctly.
3. To release the partially crimped contact, increase the air pressure of the line to  $5.5 \div 8.3$  bar and again use the crimping tool. It will then complete the crimping, allowing the indenters to return to the fully open position.

**Crimping instructions**

1. To obtain the suitable selector number, refer to the data plate located on the cover of the positioner case, and adjust the selector dial as specified.
2. Insert the contact and the prepared conductor through the opening of the indenter in the crimping tool casing (Fig. A).
3. Exert slight pressure until the crimping tool automatically crimps the contact. **CAUTION: Wire sections less than  $0.34 \text{ mm}^2$  (24 AWG) up to  $0.08 \text{ mm}^2$  (28 AWG) or equivalent are not sufficiently rigid, so that it may be rather difficult to push the contact + wire.**
4. Check the position of the crimping on the contact crimping foot. Ideally, the crimping should be between the inspection hole and the top edge of the crimping foot. The head of the contact should not be squared and the inspection hole should be intact.

**Crimping tool maintenance**

No maintenance is required. However, it is good practice to keep the indenter tips free from residual deposits of the coloured band (some types of crimp contacts as per MIL standards are identified by coloured bands in the crimping area) and any other debris. A metal brush may be used for this purpose. The following is strongly recommended:

1. DO NOT immerse the tools in a solution to clean them.
2. DO NOT brush oil in the tools to lubricate them.
3. DO NOT try to disassemble the tool or repair it.

This is a high-precision crimping tool and must be used as such.

**Installation or replacement of a positioner insert**

1. Disconnect the workshop compressed air source.
2. Disconnect the air hoses from the automatic positioner (rapid connectors).
3. Remove the connection screws, using the 3.5 mm Allen wrench (supplied with the kit), to separate the automatic positioner from the crimping tool.
4. Unscrew the positioner closing housing.
5. Install or replace the proper positioner insert in the positioner housing, replacing the underlying spring.
6. Reverse the operations, as described from point 4 to point 1.

Fig. B (automatic positioner)

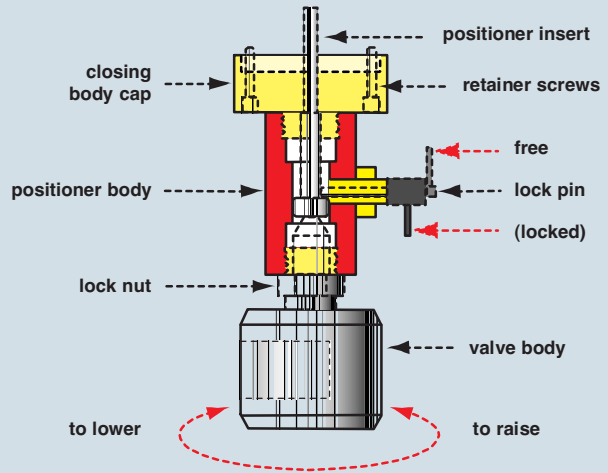

**Crimping position adjustment (Fig. B)**

1. Release the automatic positioner from the crimping tool body (see points 1 and 2 "Installation replacement of a positioner insert").
2. While holding the positioner body in position using a 19 mm wrench, loosen the lock nut with a 14 mm wrench.
3. Push the positioner insert toward the bottom and lock it using the lock pin.
4. If the pin doesn't lock, unscrew the valve body toward the bottom.
5. With the pin locked, tighten the valve body toward the top until it strikes against the positioner insert.
6. While maintaining that position, tighten the lock nut.
7. Replace and connect the positioner on the crimping tool.
8. Release the lock pin in the "free" position.

**Instructions to check calibration**

The operations to check the crimping tool must be carried out with the selector dial in position 4 and the CCPNP gauge. **CAUTION! Do not crimp the gauge.**

**Calibration check**

1. Disconnect the compressed air.
2. Push the positioner insert toward the bottom and lock it using the lock pin.
3. Reconnect the compressed air.
4. Turn the needle valve counterclockwise to open the air supply (Fig. A).
5. The indenters will extend and remain in the extracted position until the valve is closed.
6. Check using the gauge, referring to the "go / no go" instructions reported below.
7. When the calibration check has been completed, close the needle valve turning it clockwise (Fig. A).
8. Put the lock pin in the "free" position.

"GO" - Insert the end (green) of the gauge as shown (Fig. 1). The gauge must pass freely between the indenter tips.

"NO GO" - Insert the end (red) of the gauge as shown (Fig. 2). The gauge should not pass through the opening.

Gauge	tool selector pos. No.	$\varnothing A \pm 0.00254 \text{ mm}$ (go) green	$\varnothing B \pm 0.00254 \text{ mm}$ (no go) red
CCPNP	4	0.991 (mm)	1.118 (mm)

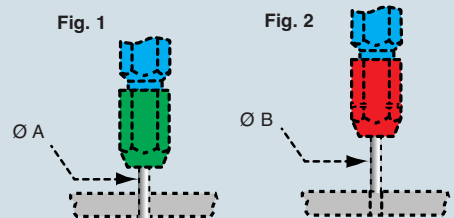

for contacts of insert series:	page
<b>CD</b> ..... (10A)	45-53
<b>CDD</b> ..... (10A)	59-66
<b>CDC</b> ..... (16A)	73-77
<b>CQ</b> ..... (16A/10A)	69-70
<b>CQE</b> ..... (16A)	80-85
<b>CCE</b> ..... (16A)	94-104
<b>CMCE</b> ..... (16A)	134-146
<b>CX 8/24</b> ..... (10A/16A)	151
<b>CX 6/36</b> * ..... (10A)	152
<b>CX 12/2</b> * ..... (10A)	153
<b>MIXO</b> ..... (10A/16A)	172-1184

\* the underlined polarities indicate those contacts that require the tools shown in this page

## stripping - crimping machine



## insertion tool

### removal tools - replacement tip



description	part No.	part No.
stripping, crimping machine Zoller+Fröhlich AM-03 Universal model	<b>ZFU-CD</b>	
insertion tool for insertion of the contacts into the inserts for crimped contacts up to 0.75 mm <sup>2</sup>		<b>CCINA</b>
removal tools for the extraction of contacts from the inserts - for <b>10A</b> contacts 1) - for <b>16A</b> contacts 2)		<b>CCES</b> <b>CQES</b>
replacement tip for CCES removal tool		<b>CCPR RN</b>

### Notes:

1) for CQ, CD, CDD, CX inserts (10A auxiliary contacts) and MIXO module (10A)

2) for CQ, CQE, CCE, CMCE inserts (excluded 16+2) and MIXO module (16A). For CDC, CMCE (16+2), CX inserts (16A contacts CX 8/24 insert) a 3 mm flat screwdriver should be used

### Technical specifications

Drive .....	electro-pneumatic
Electric feeder .....	230V/50Hz
Absorbed power .....	120VA
Fuse (on the system filter module) .....	2 x 2 A mT
Air operating pressure .....	5.5 bar
Air consumption .....	2 ml/cycle
Flexible conductors in conformity with .....	IEC 60228 class 5
Rated section .....	0.34-2.5 mm <sup>2</sup> (22 AWG-14 AWG)
Feeding length .....	52 mm
Contacts .....	loose, turned
Contact breaker .....	see list of tools
Feeding .....	vibrating conveyor
Crimping form .....	4/8 ratchets
Cycle time .....	2.5 s - 3 s
Continuous sound level .....	<70 dB (A)
Dimensions (l x d x h) .....	(530 x 500 x 480) mm
Colour .....	blue, RAL 5012
Weight .....	40 Kg

### Tools list

contacts	CD... (10A max)						CC... (16A max)					
conductor section (mm <sup>2</sup> )	0.34	0.5	0.75	1.0	1.5	2.5	0.5	0.75	1.0	1.5	2.5	
AWG (approximate)	22	20	18	18	16	14	20	18	18	16	14	
feeding bowl/male	A						B (M)					
feeding bowl/female							B (F)					
feeding tube	A						B					
wire holder	0.34	0.5-1.5				2.5	0.5-1.5					2.5
starting unit	AB						AB					
stripping blades	V-shaped blades						V-shaped blades					
rear blade spacers	0.5 mm / 1.0 mm						0.5 mm / 1.0 mm					
left/right												
contact holder / pins	A (M)						B					
contact holder / bushes	A (F)											
contact stop	A						B					

### Preset stripping and contact crimping programs

	CD... (10A max)						CC... (16A max)				
conductor section (mm <sup>2</sup> )	0.34	0.5	0.75	1.0	1.5	2.5	0.5	0.75	1.0	1.5	2.5
AWG (approximate)	22	20	18	18	16	14	20	18	18	16	14
Program number	1A	2A	3A	4A	5A	6A	7B	8B	9B	10B	11B
stripping position (mm)	0.75	1.00	1.20	1.30	1.40	1.70	1.00	1.20	1.30	1.40	1.70
crimping position	1.30	1.35	1.40	1.50	1.55	1.60	1.40	1.40	1.50	1.55	1.70

### Supplied with the following accessories:

- 1 vibrating conveyor feeder bowl for CD contact series
- 1 vibrating conveyor feeder bowl for male CC contact series
- 1 vibrating conveyor feeder bowl for female CC contact series
- 1 feeder tube (contact passage from vibrating conveyor to machine) for CD contact series
- 1 feeder tube (contact passage from vibrating conveyor to machine) for CC contact series
- 1 contact holder (in crimping position) for male CD contact series
- 1 contact holder (in crimping position) for female CD contact series
- 1 contact holder (in crimping position) for CC contact series
- 1 contact stop for CD contact series

- 1 contact stop for CC contact series
- 1 wire holder for 0.34 mm<sup>2</sup> cables
- 1 wire holder for 0.5 to 1.5 mm<sup>2</sup> cables
- 1 wire holder for 2.5 mm<sup>2</sup> cables
- 1 "GO / NO GO" control gauge
- 1 Allen wrench for setup operations
- 1 set of spacers to regulate the stripping length
- 1 removal tool to extract contacts from the crimping chamber

## General specifications

The Zoller+Fröhlich AM-03 Universal stripping-crimping machine is a semi-automatic, electro-pneumatically operated bench machine used to quickly and reliably strip flexible copper wires and to crimp loose, turned crimp male and female, **CD** series (10A max) and **CC** series (16A max) contacts in a single run.

The contacts are automatically fed by means of a vibro-conveyor unit fitted on the top section of the machine.

The machine carries out the crimping operation with four, eight pressure point indenters, in compliance with the requirements set out in the MIL-C-22520/1 standard. The stripping depth and crimping depth adjustment is controlled by a software controlled motor. Up to 50 different combinations may be stored and retrieved from the program; these combinations are useful, for example, to meet different requirements related to the wire insulator type and thickness. The adjustment and programming operations are carried out by using the keypad located on the front panel. The LCD display shows all the functions, the main information and any errors.

The machine is fitted with devices used to check that the crimping cycle has been completed.

The general safety instructions described in the machine user and maintenance manual must be followed and the use of the machine should only be restricted to qualified and trained personnel.

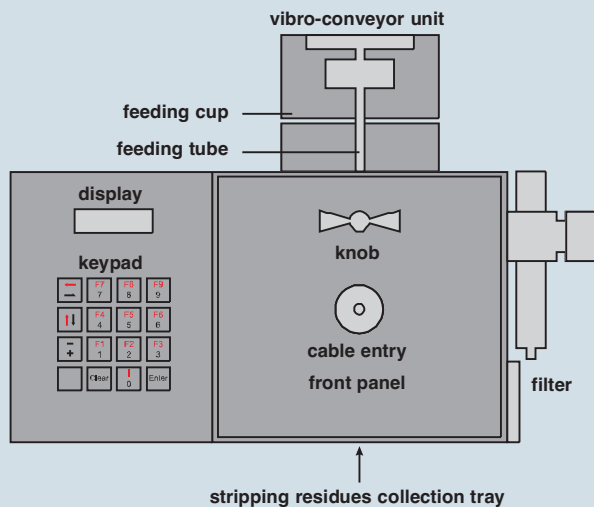

## Crimping range

Wire section: from 0.34 mm<sup>2</sup> (AWG 26) to 2.5 mm<sup>2</sup> (AWG 14).

## Description of the machine

To ensure a correct operation, the machine must be positioned on a hard bench, which does not amplify the effects of the internal movements occurring inside the machine. The machine consists of a vibrator which loads the contacts, of a tube which feeds the contacts and of a motorised wire stripping and contact crimping unit.

For each type and size of contact, the machine is provided with a factory stored preset program (see the machine user manual), which may be customised at any time. The program allows the user to: load, edit and save a program, as well as check/edit the stripping length and depth and the crimping depth.

Warning: when the machine is switched on, the working program is always the last program used.

The machine electronics adjustment is carried out by means of the keypad.

Select one of the 12 programs (see table on page 308) according to the contact used \*. Each program stores the stripping and crimping depth.

The stripping depth is the measurement in mm of how much the stripping blades must penetrate the insulator to strip it off, and depends on the type of cable used.

The crimping depth is the measurement in mm of how much the four indenters must penetrate the contact at the end of the crimping operation.

This depth depends on the size and shape of the contact (crimp shaft thickness) and determines the quality of the crimping operation in terms of gas tightness and resistance to tensile stress.

### \* Note:

the machine also has a 12C program suitable for 10 A, 2.5 mm<sup>2</sup> crimp contacts with 6 mm stripping length.

This program is therefore unsuitable for ILME CD series contacts (stripping length 8 mm).

## Operational setups

The tool carrier carriage may be accessed by opening the front door, by anticlockwise rotation of the knob, which releases the pressure from all the valves. For tool selection, see table on page 308.

- For CD series male and female crimp contacts (10A max), the feeding cup A must be fitted onto the machine, whilst for CC series crimp contacts (16A max) feeding cup B (M) for male contacts and B (F) for female contacts must be used.
- The feeding tubes to be fitted are A for CD series contacts and B for CC series contacts respectively.
- The wire holders which support the wire during the stripping stage feature three different sizes for CD contacts and two sizes for CC contacts.
- The contact holders are two (A (M) for male contacts and A (F) for female contacts) for CD series contacts, according to the different rear diameter between male and female contacts in this series, whilst there is only one holder (B) for CC series contacts.
- The contact holder is A for CD series contacts and B for CC series contacts.

## Feeding the wire

The wire must be cut straight and the single braids must not be bent or pulled apart; in particular, the first 4cm must be perfectly straight.

## Checking the stripping depth:

The machine can be operated simply as a stripping machine by disabling the crimping operation.

Please refer to the machine user manual.

## Maintenance and repairs

Stripping residues collection tray: empty the tray approximately every 2000 cycles (the frequency depends on the sizes of the stripped wire and on the stripping length).

Pneumatically controlled maintenance unit: regularly drain any water that may have collected. The trap may be cleaned with water. To remove the trap, simply disconnect the air supply. The filter unit may be unscrewed for cleaning purposes, then immersed in a cleaning agent (such as petrol or oil), thoroughly washed and dried.

## Checking the calibration values

The correct calibration of the machine must be periodically checked by using the "GO / NO GO" caliper supplied as standard with the machine, by following the procedure described in the machine user and maintenance manual.





for contacts series: page  
**CX PLF/PLM** .....189  
**CX MLF/MLM** .....189

manual crimping tool



**NEW**

polishing disc - polish paper - removal tool  
 jacket stripper and fibre stripper  
 cable cutter



description	part No.	part No.
crimping tool for POF <b>CX PL</b> and MOST <b>CX ML</b> contacts RENNSTEIG model **	<b>CLPZ R</b>	
polishing disc (RATIOPLAST 910 PS 0SC 00 001) - for POF * and MOST *** contacts		<b>CLDL</b>
polish paper: - grain size 1000 (RATIOPLAST 910 PB 001 00 001) - grain size 4000 (RATIOPLAST 910 PB 001 40 250)		<b>CLC1</b> <b>CLC4</b>
removal tool for the extraction of contacts from the CX L inserts		<b>CLES</b>
- jacket stripper (RATIOPLAST 910 AZ 001 00 PA1) for POF * and MOST *** fibre optic with PA jacket - fibre stripper (RATIOPLAST 910 AB 001 00 001) for POF * fibre optic		<b>CLSG</b> <b>CLSP</b>
cable cutter (RATIOPLAST 910 SW 001 00 001) for Ø 2.3 mm max, for POF * and MOST *** fibre optic		<b>CLTE</b>

\*\* on request tool **CLPZ RATIOPLAST**  
 910 CZ 001 00 005 for contacts POF \* crimping on  
 the back

\* POF = POLYMER OPTICAL FIBRE  
 \*\*\* MOST = MEDIA ORIENTED SYSTEM TRANSPORT

**Note:**  
 as alternative to crimping please use glue UHU  
 PLUS ENDFEST 300 (BICOMPONENT), part No.  
 "CL GL"

- 1) mix the two components on a sheet (just a drop/each)
- 2) the stripped ca. 5 mm POF \* (that means the inner fibre) has to be dipped in the glue (just 5 mm)
- 3) the POF \* has to be pushed now in the contact/ferrule
- 4) min. one night to hard/dry the glue
- 5) finally the POF \* has to be polished (polishing disc)

**CLPZ R**



**CLDL**



**CLC1 /CLC4**

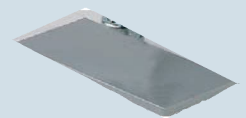

**CLES**



**CLSG**



**CLSP**



**CLTE**





**General specifications**

Strip the fibre about 12 mm for male contact and about 15 mm for female contact (see Figures 1 and 2).

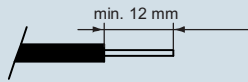

Fig. 1 - Example of cable stripping for male crimp contact

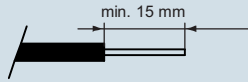
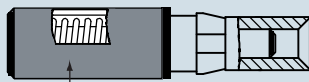

Fig. 2 - Example of cable stripping for female crimp contact

**Crimping instructions**

- The data sheet for crimping tool **CLPZ R** explains how the crimping tool works and how to adjust the crimping depth and locator for the contacts to be crimped. Position the turret on 3, push and turn of 90° the knob of turret. Adjust the crimping depth on 2 (unscrew the allen screw, after adjusting reflex the screw). For the female contact: unscrew the back of the contact, pull out the internal central part; on Figure 3 is indicated the crimping area (front part of contact). For male contact: crimp the front part of contact.
- Push the stripped fiber as far as possible into the contact sleeve so that it protrudes approx. 1 mm from the tip of the contact.



Back of contact

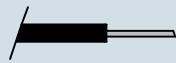

Contact/fibre crimping area

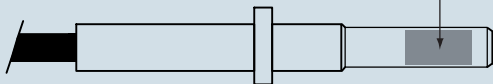

Fig. 3 - Female contact/fibre crimping area

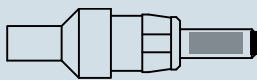

Fig. 4 - Male contact/fibre crimping area

- Insert the contact together with the fibre optic cable as far as possible into the crimping opening of the crimping tool (**CLPZ R**, see Figure 5) while applying gentle pressure to the fibre optic cable and connector, close the tool until you hear it disengages.

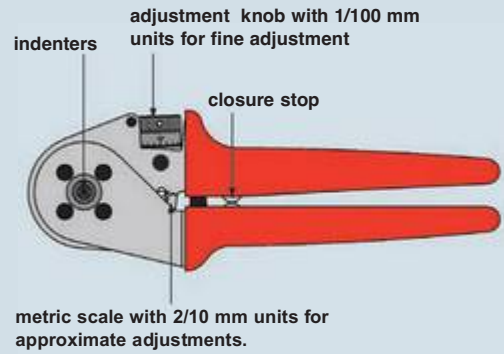
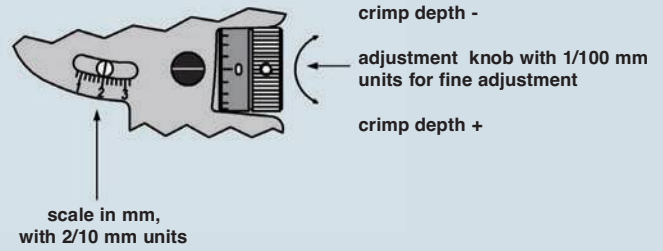

Fig. 5 - Manual crimping tool



**Finishing the front surface**

- Insert the contact into the polishing disc (**CLDL**) as shown in Figure 6.
- Work on a smooth surface (such as a sheet of glass), use grade 1000 polishing paper to grind off the protruding fibre and polish it with grade 4000 polishing paper.
- Wipe away any residue remaining after grinding.
- The best optical attenuation values are achieved when a wet grinding method is used.

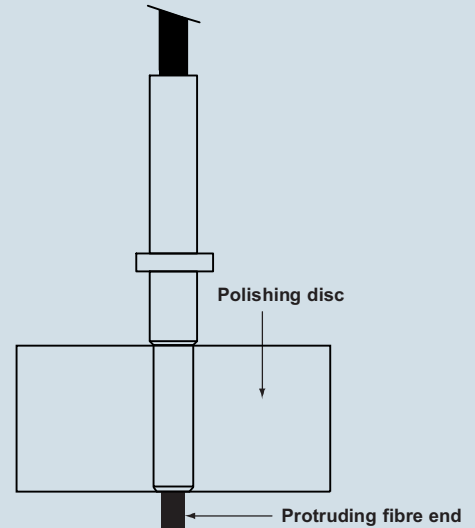

Fig. 6 - Polishing Disc with Guide for Connector Sleeve

**Final mounting instructions**

- Screw the back female part contact.
- Put inside the insert CX 04 LF/ CX 04 LM.

for contacts series:	page
<b>CX 50 F/M</b> .....	190
<b>CX 75 F/M</b> .....	190

**manual crimping tool**



**NEW**

**removal tool**



description	part No.	part No.
crimping tool for <b>CX 50 F/M</b> and <b>CX 75 F/M</b> coaxial contacts	<b>COPZ</b>	
removal tool for the extraction of contacts from the CX L inserts		<b>CLES</b>

**Crimping instructions**

- 1) strip the cable as per drawing (page 190)
- 2) crimp the central contact of coaxial connector with the position 0.7 of crimping tool
- 3) insert the central contact in the coaxial connector, put the braid shield around the back cylinder of contact
- 4) insert the brass back end on the braid shield
- 5) crimp the ferrule with position 3.25 of crimping tool

We recommend the use of code pins CRF CX / CRM CX.

As alternative to crimping, it is possible to solder the central contact.

crimping tools

**CX 50 F/M and CX 75 F/M coaxial contacts**



for insert series:

**CJ** ..... (RJ45)  
**MIXO** ..... (RJ45)

page  
 441  
 183-184

## manual crimp pliers



## screened cable stripper



description

part No.

part No.

RJ45 CJ series plug insert crimp pliers  
 basic tool YAMAICHI Y-ContTool-11 mod.  
 with plug insert inserter

**CJPZ Y**

Y-ContTool-20 cable stripper  
 cuts the cable sheath and  
 releases the wires in a single operation

**CJST**

### how to use the RJ45 plug insert crimp pliers

